

# Phase pupil filters for improvement of the axial resolution in confocal scanning microscopy

MAREK KOWALCZYK\*, CARLOS ZAPATA, ENRIQUE SILVESTRE, MANUEL MARTINEZ-CORRAL

Departamento de Optica, Universidad de Valencia, 46100 Burjassot, Spain.

Two phase pupil filters whose axial impulse response is asymmetric with respect to the focal point are proposed. It is shown that when either of the filters is placed both in the illuminating and collecting part of the system the impulse response becomes symmetric and the axial resolution increases. The filters are designed on the basis of the Fourier-transform properties of the Hermitian functions. They consist of a small number of zones ( $\leq 3$ ) whose amplitude transmittance is constant and its module is equal to unity. The width of all zones is adequately chosen. Several quantitative characteristics of the proposed filters which evidence the improvement of the axial resolution are presented.

## 1. Introduction

Confocal scanning microscopy [1] is a powerful tool for the three-dimensional (3D) imaging of fine objects. An important characteristic of a confocal scanning system is its 3D intensity point spread function (PSF) [2]. Axial behaviour of 3D PSF is a measure of the spatial resolution in the direction of axis of the system. This resolution can be improved by means of adequately designed pupil filters. However, not too much attention has been paid to the design of such filters [3]–[5].

The aim of this paper is to present a new class of nonabsorbing annular pupil filters. When a pair of filters in question is placed in a confocal system they make axial resolution increase. To prove this we analyse the axial behaviour of the 3D intensity PSF for both transmission and reflection geometries of a confocal system. We also analyse sectioning capacity through calculation of integrated intensity and confocal signal for transmission and reflection geometries, respectively. We found that improvement of axial resolution has nearly no effect on the lateral resolution.

## 2. 3D PSF of a rotationally symmetric confocal scanning system

A scheme of confocal microscope is presented in Fig. 1. Monochromatic light from a point source is focused by an objective lens  $L_1$  onto the specimen, and the transmitted light is collected by a lens  $L_2$  and refocused onto a point detector.

---

\*Permanent address: Institute of Geophysics, Warsaw University, ul. Pasteura 7, 02–093 Warszawa, Poland. E-mail [mkowalcz@plearn.edu.pl](mailto:mkowalcz@plearn.edu.pl)

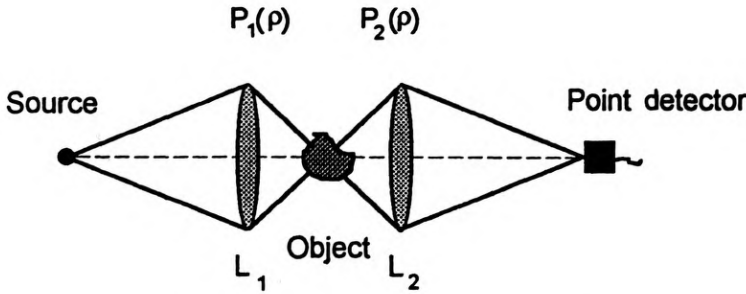

Fig. 1. Scheme of the optical system of a confocal scanning microscope

Let us introduce a normalised radial coordinate  $\rho$  in the pupil plane of  $L_1$

$$\rho = r/a_1 \quad (1)$$

where  $a_1$  is a radius of a pupil and  $r$  is the actual radial coordinate. The PSF of  $L_1$ ,  $h_1$ , is related to its complex pupil function  $P_1$  by the following integral transform:

$$h_1(v, u) = 2 \int_0^{\infty} P_1(\rho) \exp\left(\frac{1}{2} i u \rho^2\right) J_0(v \rho) \rho d\rho, \quad (2)$$

here  $v$  and  $u$  are cylindrical optical coordinates defined by:

$$v = k r \sin \alpha, \quad (3)$$

$$u = 4 k z \sin^2(\alpha/2), \quad (4)$$

in which  $k = 2\pi/\lambda$  is the wave number,  $\alpha_1$  is the angular aperture of the objective lens  $L_1$ , and  $z$  is the actual axial coordinate whose origin coincides with the confocal point. The PSF of the collecting lens  $L_2$  depends on whether we deal with a transmission or reflection system

$$h_2(v, u) = 2 \int_0^{\infty} P_2(\rho) \exp\left(+\frac{1}{2} i u \rho^2\right) J_0(v \rho) \rho d\rho \quad (6)$$

for a reflection system, and

$$h_2(v, u) = 2 \int_0^{\infty} P_2(\rho) \exp\left(-\frac{1}{2} i u \rho^2\right) J_0(v \rho) \rho d\rho \quad (6)$$

for a transmission one. The 3D intensity PSF, *i.e.* the 3D image of a point object, is given by

$$I(v, u) = |h_1(v, u) h_2(v, u)|^2. \quad (7)$$

For a transmission system with two equal pupils, *i.e.*  $P_1 = P_2$ , we have from Eqs. (6)

and (7) that

$$I_r(v, u) = |h_1(v, u)h_1(v, -u)|^2. \quad (8)$$

When  $h_1$  is symmetric in variable  $u$ , the minus sign in Eq. (8) is inessential. For asymmetric PSF it has some consequences which are important from the standpoint of the design of superresolving pupils. In order to maintain the relation of Eq. (8) in a reflection-mode system (Fig. 2) one has to use a pair of complex conjugated pupil filters

$$P_2(\rho) = P_1^*(\rho) \quad (9)$$

which yields

$$I_r(v, u) = |h_1(v, u)h_1^*(v, -u)|^2. \quad (10)$$

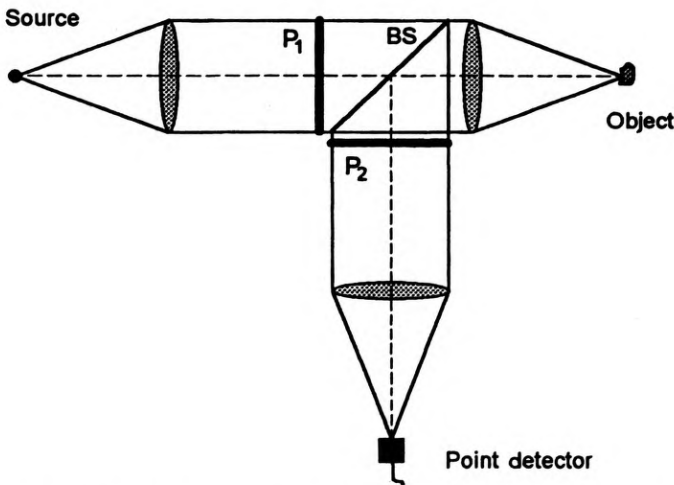

Fig. 2. Schematic layout of the reflection-mode confocal scanning microscope. *BS* — beam splitter,  $P_1$ ,  $P_2$  — pupil filters

We are interested in intensity distribution so that the complex conjugation in Eq. (10) is inessential.

### 3. Pupil functions for asymmetric axial apodization

To analyse axial behaviour of the 3D intensity PSF, we put  $v = 0$  in Eq. (2). If, in addition, we use a mapping

$$\rho^2 - \frac{1}{2} = t, \quad (11)$$

we obtain

$$h_1(u) = \exp(iu/8\pi) \int_{-0.5}^{0.5} q_1(t) \exp(iut/2) dt \tag{12}$$

where  $q_1(t) \equiv P_1[\rho(t)]$  and  $h_1(u) \equiv h_1(0, u)$ . Equations (8), (10) and (12) yield

$$\begin{aligned} I_1(u) = I_r(u) &= \left| \int_{-0.5}^{0.5} q_1(t) \exp(iut/2) dt \right|^2 \left| \int_{-0.5}^{0.5} q_1^*(t) \exp(iut/2) dt \right|^2 \\ &= |h_1(u)|^2 |h_1(-u)|^2. \end{aligned} \tag{13}$$

Thus we expressed axial behaviour of the 3D intensity PSF in terms of Fourier transform of  $q_1(t)$ . It results from the Fourier transform theory that in order to obtain an asymmetric  $|h_1(u)|^2$ , the function  $q_1(t)$  must be either Hermitian or anti-Hermitian [6].

To proceed further we restrict our interest to Hermitian functions  $q_1(t)$ . Such functions are complex and have symmetric real part and antisymmetric imaginary part. Pupils for which  $q_1(t)$  is Hermitian will be referred to as Hermitian pupils. It should be stressed that whereas  $q_1(t)$  is Hermitian, the actual pupil function  $P_1(\rho)$  is neither Hermitian nor anti-Hermitian. Some very Hermitian pupil functions were proposed by Cheng and Siu for apodization of slit pupils to improve lateral resolution in conventional (nonfocal) imaging systems [7]. In such a case, the price which is paid for improved resolution is lack of symmetry of the PSF. On the contrary, in a confocal system the 3D intensity PSF is both superresolving and symmetric in  $u$ , although  $h_1$  itself is asymmetric. This takes place owing to the product relation of Eq. (13). To show this we consider a simple Hermitian function  $q'_1(t)$  whose real part is constant and imaginary part is a properly normalised signum function (Fig. 3)

$$q'_1(t) = \begin{cases} (1+i)/\sqrt{2}; & -0.5 \leq t \leq 0 \\ (1-i)/\sqrt{2}; & 0 \leq t \leq 0.5 \\ 0; & \text{otherwise} \end{cases} \tag{14}$$

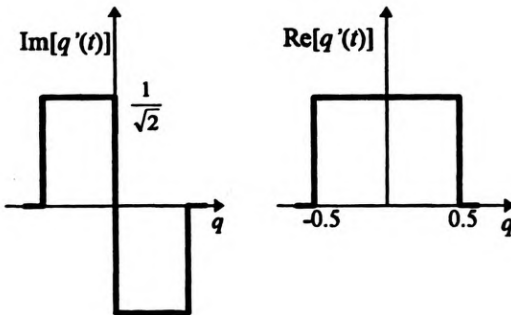

Fig. 3. Real and imaginary parts of the pupil function  $q'(t)$ , (Eqs. (14))

It is easy to show that  $q'(t)$  is a legitimate transmittance function, i.e.  $|q'(t)|^2 \leq 1$  and corresponds to a simple two-zone pupil. The pair of actual pupils  $P'_1$  and  $P'_2$  which should be used in a reflection-mode system is shown in Fig. 4. In a transmission-mode system either two pupils  $P'_1$  or two pupils  $P'_2$  can be used as well.

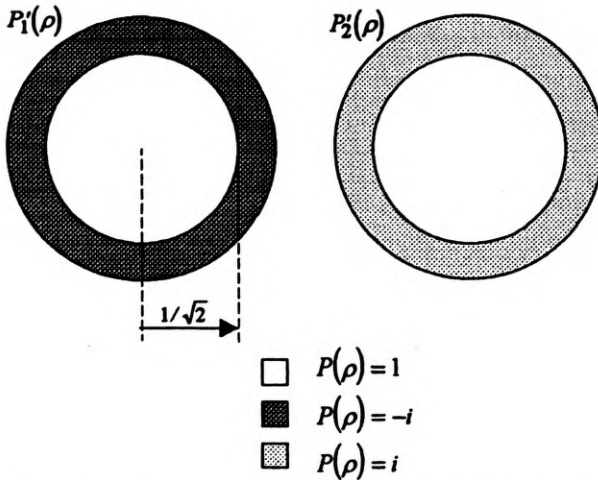

Fig. 4. Pair of complex conjugate pupils. Pupil  $P'_1$  is described by Eqs. (14) and (11). In the figure, unlike in Eq. (14), we put for convenience  $\arg[q'(t)] = 0$  for  $-0.5 \leq t \leq 0$ . This is of no consequence as the phase shift  $\Delta\varphi$  between the wavefront transmitted by the central disk and that transmitted by the outer ring is preserved.  $\Delta\varphi = -\pi/2$  for  $P'_1$  and  $+\pi/2$  for  $P'_2$

Axial behaviour of the impulse response of a conventional imaging system with the pupil function  $P'_1$  and that of a two-pupil confocal scanning system are presented in Figs. 5 and 6, respectively.

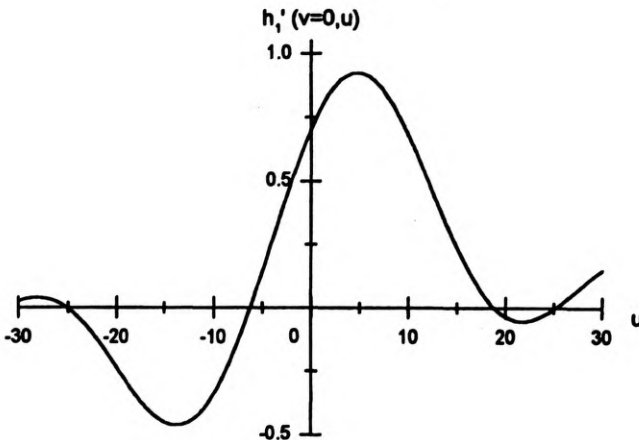

Fig. 5. Axial distribution of the light amplitude in the image of a point source in a conventional imaging system with the pupil function  $P'_1$

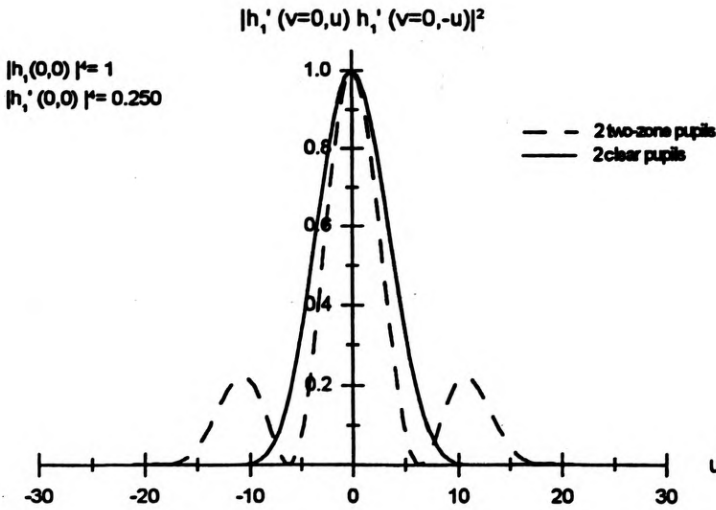

Fig. 6. Normalized axial distribution of the intensity signal in the image of a point source in a confocal scanning microscope (dashed curve) compared with that obtained for two clear pupils

It is seen that improvement of axial resolution is accompanied by an increment of side lobes, which is usual effect observed for superresolving pupils.

In order to properly design a superresolving light-efficient pupil function  $P_1(\rho)$ , we should take into account the following relations between  $q(t)$  and  $h(u)$  which hold for any Hermitian  $q(t)$

$$h(0) = \int_{-\infty}^{\infty} q_e(t) dt, \quad (15)$$

$$\left. \frac{\partial h(u)}{\partial u} \right|_{u=0} = \int_{-\infty}^{\infty} q_o(t) t dt, \quad (16)$$

and that for the most light-efficient pupil

$$q_e^2(t) + q_o^2(t) = 1 \quad (17)$$

where  $q_e$  and  $q_o$  are the real and imaginary parts of  $q$ , respectively, with  $q_e$  being even and  $q_o$  odd function. A good superresolving performance can be attributed to high value of the first derivative of  $h(u)$  at the origin, hence by virtue of Eq. (16), to the first moment of  $q_o(t)$ , whereas the brightness in the image of a point object to the average value of  $q_e(t)$ . Maximum brightness is obtained for  $q_e(t) \equiv 0$  for which  $h(u)$  takes zero slope at the origin. Similarly, maximum slope is obtained for  $q_o(t) = \text{sgn}(\pm t)\text{rect}(t)$  and  $h(0) = 0$ . Thus, the requirement to obtain high brightness and good super-resolution is contradictory and certain compromise should be established. Taking into account the above considerations and the requirement of technological simplicity we propose the following pupil function (Fig. 7):

$$q''(t) = \begin{cases} i, & -0.5 \leq q < -0.25 \\ 1, & -0.25 \leq q < 0.25 \\ -i, & 0.25 \leq q \leq 0.5 \\ 0, & \text{otherwise} \end{cases} \quad (18)$$

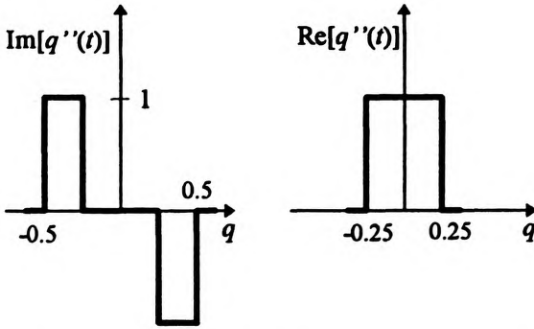

Fig. 7. Real and imaginary parts of the pupil function  $q''(t)$ , (Eqs. (18))

The actual three-zone pupils  $P_1''$  and  $P_2''$  which should be used in a reflection-mode system are shown in Fig. 8.

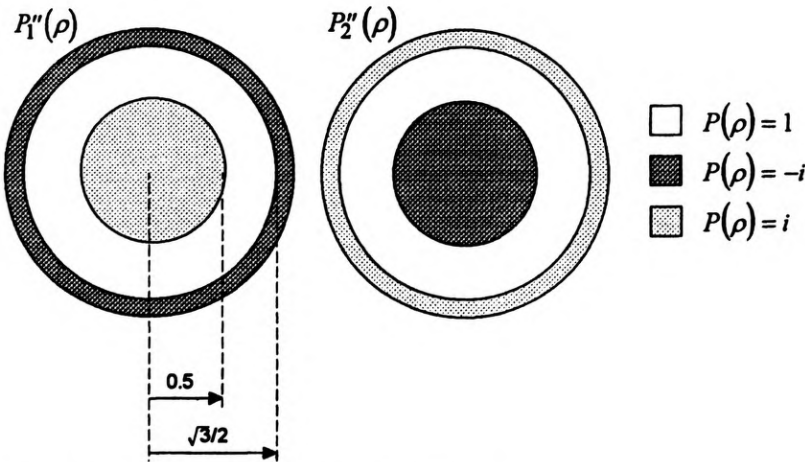

Fig. 8. Pair of complex-conjugate three-zone pupils

Axial behaviour of the impulse response of a conventional imaging system with the pupil function  $P_1''$  and that of a two-pupil confocal scanning system are presented in Figs. 9 and 10, respectively.

As regards the two-point axial and lateral resolution, the performance of the pupils  $P_1''$  and  $P_2''$  is compared with those of nonapodized system in Figs. 11 and 12, respectively.

From the point of view of spatial resolution we can characterise the 3D intensity PSF by its full width at half the maximum height. Using this parameter as a merit

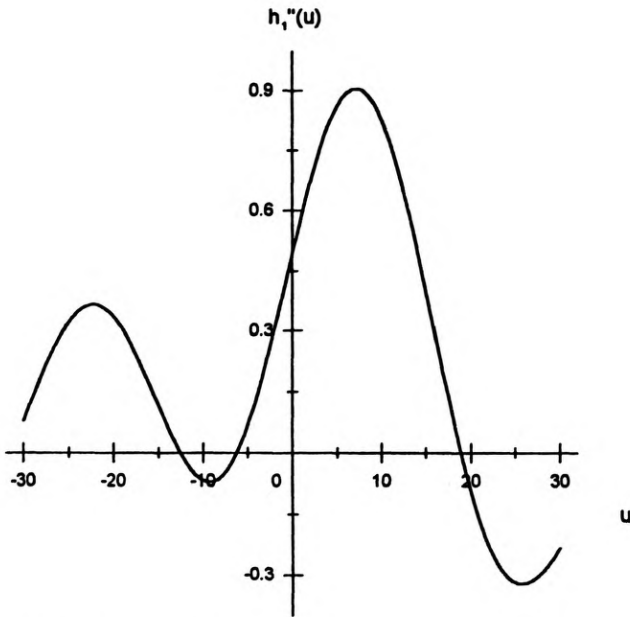

Fig. 9. Axial distribution of the light amplitude in the image of a point source in a conventional imaging system with the pupil function  $P_1''$

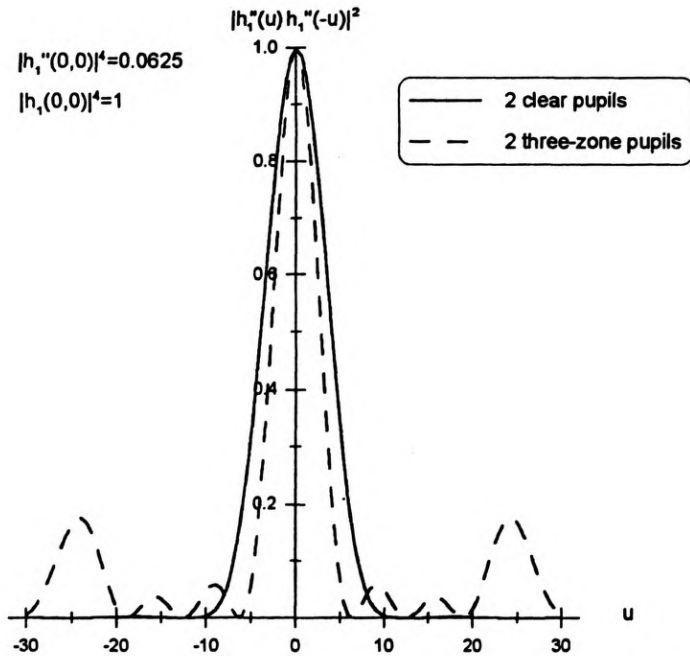

Fig. 10. Normalized axial distribution of the intensity signal in the image of a point source in a confocal scanning microscope (dashed curve) compared with that obtained for two clear pupils



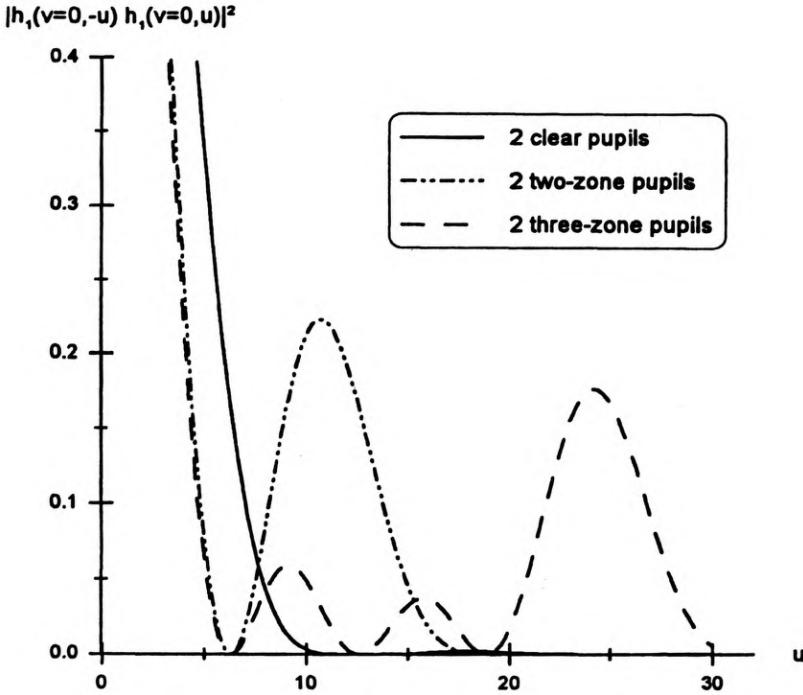

Fig. 11. Normalized one-sided axial distributions of the intensity signal in the image of a point source given by confocal imaging systems with pupils  $P_1'$  and  $P_1''$ . In the figure these distributions are compared with that for nonapodized system (solid curve)

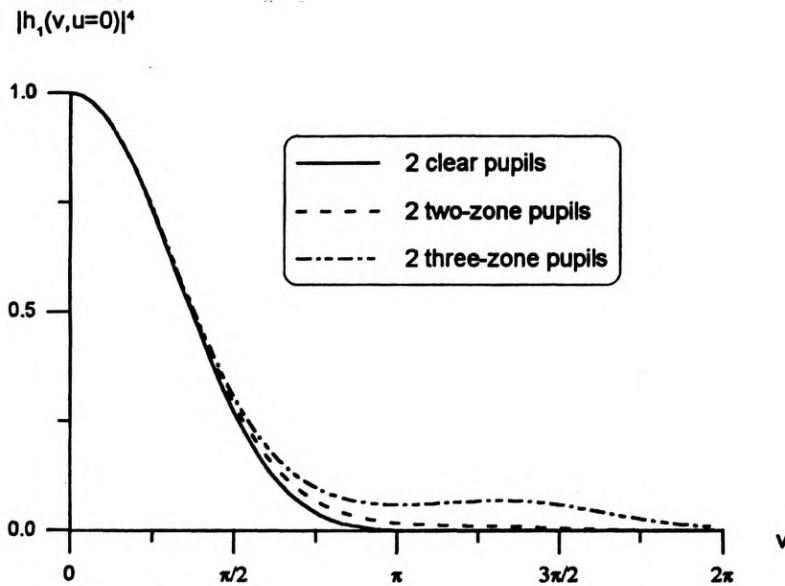

Fig. 12. Normalized lateral distribution of the 3D intensity PSF for  $u = 0$

function we can state that by means of simple Hermitial pupils one can reach a 30% gain in axial resolution, preserving the lateral resolution nearly unaffected.

Another important characteristic of the confocal imaging is its capacity of sectioning. In case of transmission-mode system, the so-called integrated intensity is used as a measure of this capacity. The integrated intensity is defined as follows [1]:

$$I_{\text{int}}(u) = 2 \int_0^{\infty} |h_1(v, u)h_2(v, u)|^2 v dv. \quad (19)$$

Making use of Equations (2), (6), (11), (14) and (18) we calculated numerically the integrated intensity for transmission-mode systems with pupils  $P'_1$  and  $P''_1$ . The results are presented in Fig. 13.

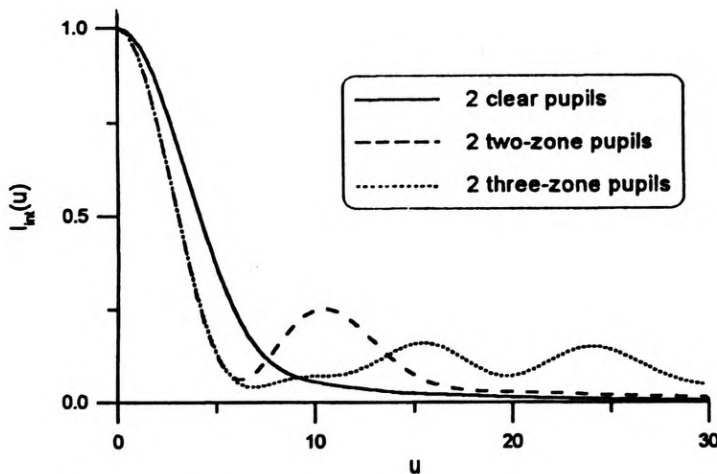

Fig. 13. Integrated intensity for a confocal scanning systems with pupils  $P'_1$  and  $P''_1$

It is seen that Hermitian pupils  $P'_1$  and  $P''_1$  provide a 30% gain in the sectioning capacity. In the case of reflection-mode systems we use rather the confocal signal and not the integrated intensity. The confocal signal is, by definition, the signal received by a point detector when a perfect reflector, perpendicular to the axis of illuminating system, moves axially in the vicinity of the confocal point. This magnitude can be expressed in terms of mapped pupil functions as follows:

$$I(z) = \left| \int_{-\infty}^{\infty} q_1(t)q_2(t) \exp(2\pi izt) dt \right|^2 \quad (20)$$

Since  $q_1(t) = q_2^*(t)$  and  $|q_1(t)| = |q_2(t)| = 1$ , Eq. (20) reduces to that for the system with two clear pupils. Thus, no gain in confocal signal is obtained. This holds for any pair of complex-conjugate purely-phase pupils.

## 4. Conclusions

The following conclusions can be drawn from the considerations presented in the preceding sections:

– Taking into account the two point resolution criteria the axial resolution of confocal scanning system with two Hermitian pupils increases both in transmission and reflection geometry, whereas transversal resolution remains unaffected.

– The sectioning capacity whose measure is integrated intensity (transmission geometry) also increases.

– The sectioning capacity whose measure is confocal signal remains equal to that of the system with two clear pupils.

– The resolution gain which is about 30% can be improved as all the free parameters (number and radii of annular zones, magnitude of phase shift) were chosen in an arbitrary manner and no optimizing procedure was performed.

*Acknowledgements* – Marek Kowalczyk is grateful to the Spanish Ministry of Culture and Education and the University of Valencia for their support which made possible his research study at the Optics Department of this University.

## References

- [1] WILSON T., SHEPPARD C., *Theory and Practice of Scanning Optical Microscopy*, Academic, London 1984.
- [2] SHEPPARD C. J. R., COGSWELL C. J., *Three-dimensional imaging in confocal microscopy*, [in] *Confocal Microscopy*, [Ed.] T. Wilson, Academic, London 1990, pp. 142–169.
- [3] MARTINEZ-CORRAL M., ANDRÉS P., OJEDA-CASTAÑEDA J., SAAVEDRA G., *Optics Commun.* 119 (1995), 491.
- [4] SHEPPARD C. J. R., *Optik* 99 (1995), 32.
- [5] MAGIERA A., *Opt. Appl.* 26 (1996), 57.
- [6] BRACEWELL R., *The Fourier Transform and Its Applications*, McGraw-Hill Book Co., New York 1965.
- [7] CHENG L., SIU G. G., *Meas. Sci. Technol.* 2 (1991), 198.

Received July 22, 1998