

Fiber Optics Department of Biaglass Co. Twenty years of research activities

JAN DOROSZ

Biaglass Co. and Technical University of Białystok, 15–138 Białystok, Poland.

RYSZARD ROMANIUK

Warsaw University of Technology, 00–665 Warszawa, Poland.

The paper presents recent developments in optical fiber technology at the Research Production Department of Fiber Optics (in short Fiber Optics Department – FOD). The work on optical fibers was launched by the Białystok Glass Works (BGW), now Biaglass Co., in 1978. A special Fiber Optics Department was created there a few years later. This fact reflected at that time the dynamically developing research and manufacturing of soft-glass optical fibers, fiber components, sub-assemblies, devices, cables, bundles, illuminators, image-guides, sensors, and complete fiberoptic systems for research, biomedical, environmental, industrial and military applications. This year marks the 20th anniversary of research and manufacturing of optical fibers, components and photonic systems at BGW and Biaglass Co. The present paper is the first of the whole series to be published in *Optica Applicata* and the *Proceedings of SPIE*, which will focus on activities of a group of people who have been engaged in the aforementioned enterprises from the very beginning. The scope of interest will be limited to technology of optical fibers, theoretical investigations and construction of apparatus with the use of such optical fibers.

1. Introduction

After nearly a quarter of century since its advent, the fiberoptic technology, as an important branch of photonics, is still developing and establishing its solid and valuable applications in different niches of technologies and social life. The span of these applications is extremely broad and still expands:

- Everyday life (customer photonic devices).
- Communications (fiber-to-the-home, ultra-broadband individual household communication services).
- Medicine (image-guides and endosurgery, broadband monitoring of patient in the near future).
- Environmental protection and municipal engineering systems (distributed monitoring systems).
- Industry (metrology, communication, sensors, power delivery, photography, photocopiers, printers, photonic devices, telemetric systems, photonic systems, etc).
- Research (new fibers, new sensors, physics, astronomy, novel applications, etc.).

A group of researchers and manufacturers associated with the Fiber Optics Department at BGW and Biaglass Co. have been contributing actively to some of these fields for 20 years now. Today the FOD of Biaglass, unified with Optoelectronics Laboratory of Technical University of Białystok, under the same chairmanship, and cooperating with many photonics research institutions over the country, is one of the leading fiberoptic technological laboratories, with a considerable research impact. The FOD consists of several sub-departments, the main two of them being: technological research sub-department combined with photonics measurement laboratory and industrial manufacturing sub-department combined with product quality assessment laboratory. The paper presents a concise digest of research and manufacturing achievements of the FOD at BGW and Biaglass Co. during the last twenty years. These works are presented against the broad background of fiberoptics technology in Poland.

The following abbreviations are used throughout the paper and in other papers of the series: PERP – Photonics Engineering Research Program, PERG – Photonics Engineering Research Group, WUT – Warsaw University of Technology, PAN – Polish Academy of Sciences, BGW – Białystok Glass Works, FOD – Fiber Optics Department, UMCS – University of Maria Curie-Skłodowska, TUB – Technical University of Białystok, OLPiT – Lublin Telecommunication Research Laboratory, SPIE/PL – Polish Chapter of SPIE, DC – double crucible process, MMC – modified multicrucible process, RIP – refractive index profile.

2. Fiberoptic research scene in Poland

The initial works in fiberoptics carried out in Poland were summarized during the first national symposium on *Optical Fibers and Their Applications*, organized in Jabłonna Palace near Warsaw in February 1976 [1]. This series of symposia, after some organizational changes, has been continued until today in two main streams. One is organized by the UMCS every one and a half year and the second by Biaglass also every one and a half year. There are a few volumes of SPIE Proceedings issued from these meetings. The previous ones include: vol 670, *Optical Fibers and Their Applications IV*, 1986, and vol. 1085, *Optical Fibers and Their Applications V*, 1989 (both edited by M. Szustakowski and R. Romaniuk), vol. 3189, *Technology and Applications of Light Guides*, 1996, edited by J. Wójcik and W. Wójcik from Lublin, Vol. 3555 *Optical Fibers and Their Applications VI*, 1998, edited by J. Dorosz and R. Romaniuk. Research in fiberoptics started in Poland around 24 years ago.

2.1. Optical fiber technological research laboratories in Poland

Four major technological fiberoptics laboratories existed at the early fiberoptics time in Poland. These were:

- University of Maria Curie-Skłodowska in Lublin, Optical Fiber Laboratory located at the Faculty of Chemistry. This group started from the cooperation with the Institute of Telecommunication of Warsaw University of Technology. The first fibers manufactured in 1975 there liquid core silica glass capillaries.

– Semiconductor Materials Research and Manufacturing Center (CEMAT) in Warsaw embracing several institutions, among them the Institute of Electronic Materials Technology (ITME), Optical Fiber Technology Laboratory was created there around 1975, based on the strong group of researchers working on high quality glasses and ceramics for electronics and optics.

– Optical Fiber Technological Laboratory was created at the Institute of Physics, Chemistry and Mathematics of Technical University of Białystok around 1976. This group was engaged successfully in the Fiberoptics Program realized by ITME/CEMAT at that time.

– Optical Fiber Technology group was started at Białystok Glass Works in 1978 in cooperation with Technical University of Białystok and soon with Warsaw University of Technology and UMCS.

The Fiberoptics Laboratory (FOL) at the UMCS has been carried out research in the domain of high silica CVD fibers since 1994/1995. University workers from this laboratory, understanding the need of establishing relations with the industry, quickly undertook close cooperation with local telecommunication research laboratory (OLPiT). This co-operation assured that the work done there always had sound telecommunication oriented application background. The fibers, and next optical cables, from the UMCS (and later, from a separate OLPiT-based fiber optic pulling factory) have started professional optical telecommunications in Poland [1]. The first post office experimental optical fiber link implemented by this group was in Lublin in 1979.

The ITME Fiberoptics Laboratory had, at that time, the best theoretical and practical background in the domain of high quality glass technology. This resulted in 1976 in launching quite a big research program of optical fiber technology, sponsored by the national budget. The ITME FOL specialized in soft glass optical fibers, fiberoptics and in PCS fibers. It soon started to manufacture a broad spectrum of commercial fiberoptical off-the-shelf products [1]. The fiberoptics laboratory at Electronics Materials Center in Warsaw has been active in soft glass and PCS optical fibers and devices over a similar time span. This laboratory co-operated with fiberglass department of Ożarów Glass Works near Warsaw in the very beginning of its work in this field. The major research effort of this laboratory was in the area of fiber quality glass technology and fiberoptical stiff and flexible image-guides.

The Fiberoptics Technology Laboratory at the Technical University of Białystok started as a research partner of ITME laboratory around 1976 with a similar research scope and aims, but without production branch.

The year 1978 was marked at BGW by the first experimental work on manufacturing of optical fibers based on the crucible technology [2]. At first, the prototype drawing and supplementary technological apparatus were constructed. The fiber drawing process was mastered [3]. First optical fiber bundle cables were manufactured that year. The individual fibers in bundles had then about 30 μm in diameter with around one dB/m of attenuation. The fibers were manufactured as step index ones from lead glass.

2.2. Design and realization of FOD at BGW

After finishing the initial stage of technology development, the national market demand for fiberoptics was broadly investigated. Medical, industrial and research institutions were the main customers of fiberoptics at that time. In order not to isolate the technological center, it undertook cooperation with the customers and some research institutions interested in fiberoptic technology and applications. Some of these institutions were: Warsaw University of Technology, Technical University of Białystok, University of Maria Curie-Skłodowska in Lublin, Military Academy of Technology in Warsaw and Wrocław University of Technology. Researchers from these and other institutions undertook close co-operation with technological fiberoptic laboratory of BGW. This resulted soon in a considerable increase in the number and quality of works carried out in the field of fiberoptics in Poland (Fig. 1).

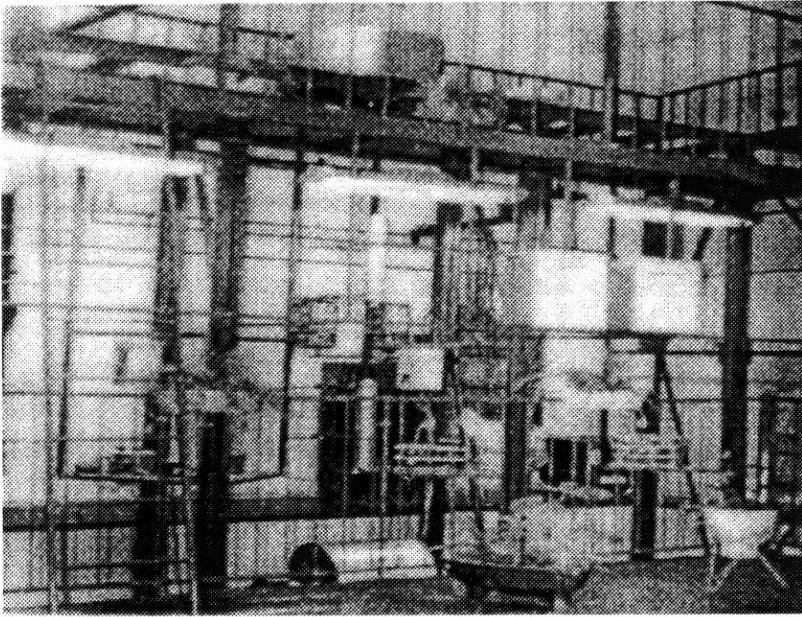

Fig. 1. Fiber optic drawing facilities at the FOD of BGW. There is seen the equipment for all parts of the technological process for optical fiber pulling, covering, in-line measuring and arranging in a coherent way. White boxes contain basic measuring, steering and automation equipment

The above mentioned laboratories obliged themselves to support research at the FOD of BGW. Optical and mechanical properties of optical fibers and fiber optic components manufactured at FOD were measured initially in the co-operating laboratories. At that time, however, the major work was carried out in the domain of possible applications for optical fiber and fiber optic components. Instrumental systems were considered then as the major field of applications of fiber optic components, devices and photonic sub-systems. The results of these investigations

were fed back to the technological processes, as soon as possible, to embrace the emerging new trends in applications and research (Fig. 2).

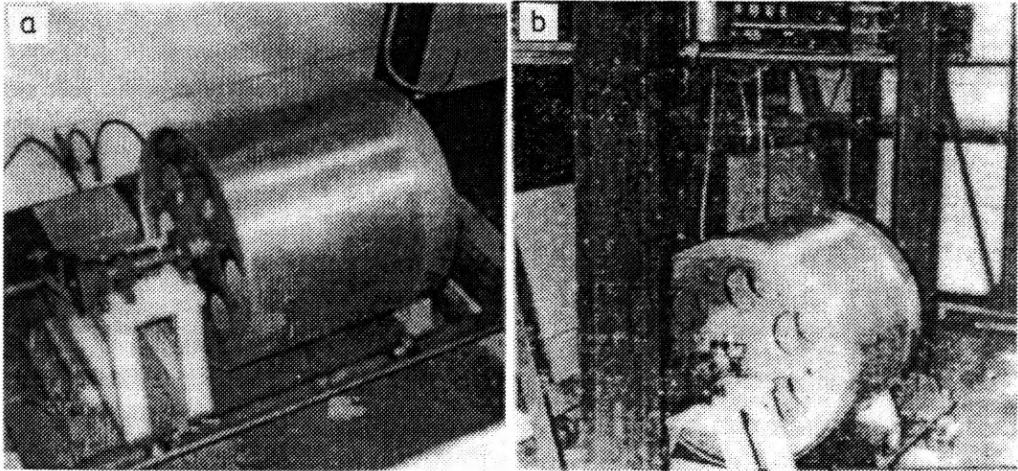

Fig. 2. Optical fiber pulling drums for optical fibers (a) and coherent fiber bundles (b) at the FOD of BGW

Independent of the above, a separate co-operation was launched with other leading glass works around the country, especially Jelenia Góra Glass Works (JZO), Poland, which carried out research on high quality glasses for professional and off-the-shelf customer optics and optical systems. The JZO started at that time some research on quality multicomponent glasses for fiberoptics. Apart from low-loss oxide glasses, some other compositions with zirconium, cerium and fluoride were investigated. The latter glasses were designed for special fiberoptics applications including areas of increased ionizing radiation background. Radiation hardened fiberoptics has slowly turned with time to a separate and profitable branch of technology at the FOD of BGW [4]–[6].

The promising results of initial research, extensive domestic market analysis, and support from other research institutions all over the country, encouraged the initiators to start to organize a permanent Fiberoptic Department at the BGW around the 1980. The project assumed large technological flexibility and metrological self-sufficiency of the FOD. This kind of redundant design of the industrial laboratory allowed the FOD to manufacture, investigate, and measure a broad spectrum of optical fibers, components and photonic devices.

The FOD was placed in a special separate laboratory hall of more than 200 m² [7]. The hall was partly insulated from atmospheric pollution. The hall was also equipped with drawing towers. Three independent (parallel) drawing sets were available. Two sets were used for production purposes while the thirs for research. Each set consisted of a syllite furnace, supply and automation units, temperature measurement, temperature regulation and stabilization, multiple fiber protective coating system, automated pulling device. The pulling drum had a very precisely

and fluently regulated rotation and transverse movement to receive either coherent one layer or multi-layer optical fiber ribbons. The diameter of the early drum was 63 cm. The rotation speed regulation was possible in the range of 0–10 rotations per second. The speed of pulling changed from 0 to 20 m/s. At some stage, a laser diameter controller was applied for fiber diameter feedback control. The multi-point temperature control of the furnace was possible with the accuracy much better than 0.1 °C, on the typical level of 800–1200 °C, for multicomponent glasses. Power of the furnace was between 15 and 20 kW. A cylindrical chamber of the furnace was 350 mm in diameter. The heating spiral elements were placed parallel to the axis of pulled fiber, giving proper homogeneous temperature distribution. Temperature measurements inside the furnace were done by the PtRh-Pt thermocouple. The research furnace was equipped with closed gas argon flow installation, to ensure

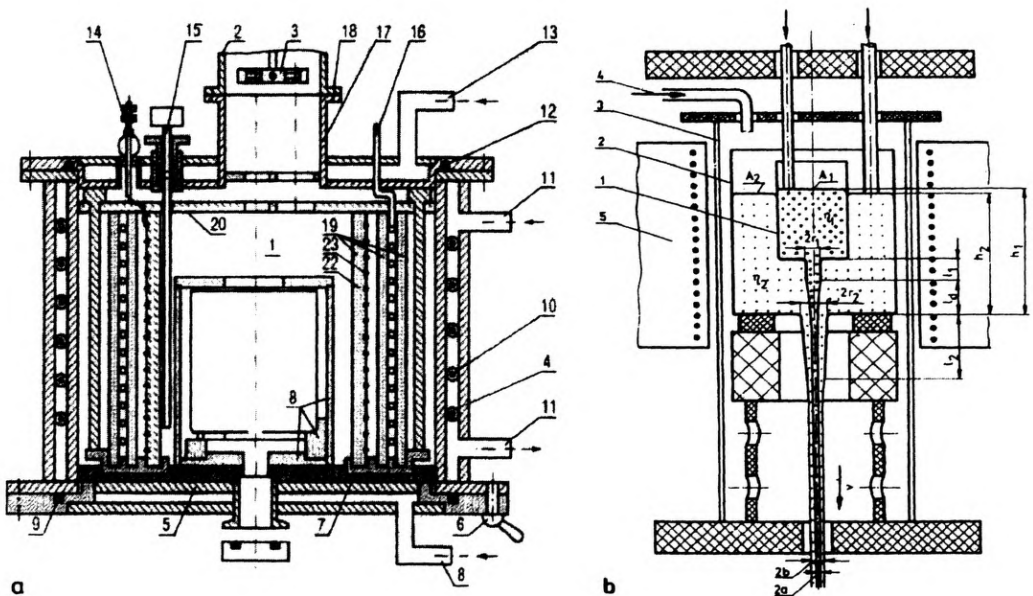

Fig. 3. Cross-sections of multi-functional furnaces, for crucible technology of optical fibers, at FOD of BGW. a: 1 – work chamber, 2 – crucible supply unit, 3 – support, 4 – external steel package of double walls, with ceramic insulators inside, 5 – mobile bottom, which can easily be removed and fixed with quick screw junctions – 6, 7 – ceramic screen resting on the base of the furnace, 8 – ceramic scaffold supporting crucibles, 9 – bottom cooling inlet, 10 – wall cooling chambers, 11 – wall cooling inlet, 12 – ring gasket, 13 – top cover cooling inlet, 14 – electrical bushings, 15 – thermopair seal wires, 16 – connector pipe to gas and vacuum systems, 17 – package of crucible supply unit, 18 – sealed junction, 19, 20 – alundum screens for thermal insulation, 21 – holder of ceramic tubular thermal screens, 22 – internal thermal diffuser, 23 – heating spiral. b: 1 – core crucible, 2 – clad crucible, 3 – screen, 4 – gas system inlet, 5 – heating system, letters inside the crucible chamber denote technological process parameters influencing resulting fiber data: A_1, A_2 – glass surfaces in crucibles, η_1, η_2 – glass viscosities, r_1, r_2 – nozzle radii, h_1, h_2 – liquid heights, l_1, l_2 – spout lengths, l_d – diffusion length, v – velocity of fiber pulling, a, b – core-cladding proportions in resulting DC fiber. Optical fiber pulling furnaces of another construction are available for special purposes

clean high temperature environment and laminar gas flow around hot fiber (Fig. 3).

A versatile measurement laboratory was built in the FOD at BGW and at the adjacent Technical University of Białystok (Optoelectronics Laboratory). The measurement laboratory focused mainly on the technological photonics metrology and quality investigations of fiberoptic components. Technological investigations embrace: control of input materials, glass quality, control of particular stages of the technological process (Figs. 4, 5), [8]–[10].

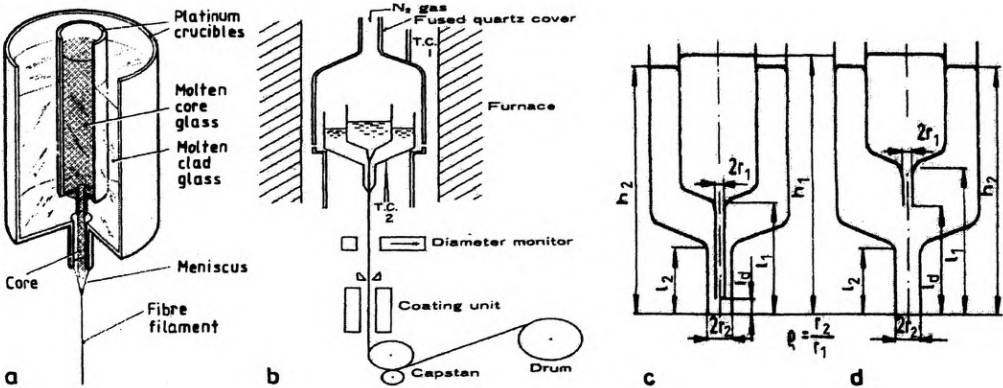

Fig. 4. Illustration of optical fiber manufacturing in classical double crucible process – a, b. In figures c and d the difference between crucible set-up for step-index and gradient index DC optical fibers is emphasized. DC process parameters, influencing the properties of optical fiber are shown: h_1, h_2 – heights of fluid glass, l_d – diffusion length, l_1, l_2 – lengths of spouts in nozzles, r_1, r_2 – radii of output apertures

The fiber under pulling undergoes a continuous in-line or off-line control of the following parameters:

- optical fiber diameter stability,
- furnace light intensity fading during fiber pulling,
- transmitted light colour under the excitement of white light,
- visible and near infrared light spectral characteristics,
- basic mechanical characteristics such as: breaking bending diameter, tensile strength, *etc.*, and dependence of these characteristics on the cover quality,
- differential mechanical properties of core-cladding component glasses, internal and core-cladding stresses,
- numerical aperture (NA),
- refractive index profile (RIP),
- dispersion of NA and RIP,
- glass ions diffusion processes, depending on thermal characteristics of the fiber pulling process and characteristics of technological hardware.

The above parameters are fed to the Fiberoptic Laboratory technological database. This large fiberoptic technological database will soon be available through

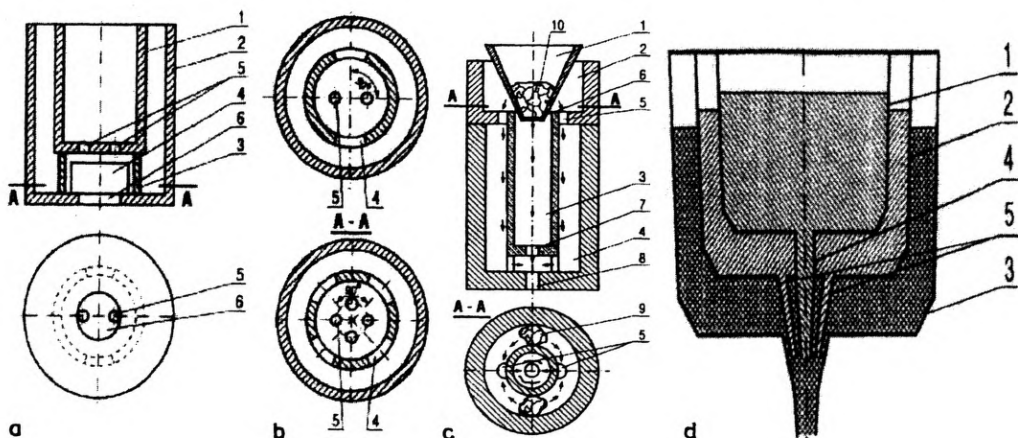

Fig. 5. Configuration modifications of crucibles in the MMC optical fiber process at FOD of BGW. **a** and **b** – MMC process with inter-crucible diaphragm. 1 – internal crucible, 2 – external crucible, 3 – cylindrical diaphragm between crucibles with two or more throughput channels – 4, 5 – multiple nozzles in core crucible, 6 – cladding crucible nozzle. **c** – continuous glass supply for MMC process. 1 – container for core glass, 2 – container for cladding glass, 3, 4 – core and cladding crucibles, 5 – cladding glass supply throughputs, 6 – core glass supply throughput, 7, 8 – calibrated nozzles in crucibles, 9 – batch glass, 10 – core glass melt. **d** – MMC process with internal separation, in the simplest solution. 1 – internal crucible, 2 – intermediate crucible, 3 – external crucible, 4 – connecting spout, 5 – nozzles for multiple cores

the Internet, under the address <http://nms.ipe.pw.edu.pl>. The database is used in local computing system as part of a newly built expert system on MMC process. The expert system analyses will allow automated optimization of all parts of fiber pulling process. This automation is necessary as the FOD manufactures much customized products in small quantities. Very customized means here that the products are very different from each other, thus requiring quite individualized approach. Reloading of technological lines (fiber pulling and assembly) for different products, and doing it manually, is pretty burdensome and time consuming. The expert system is already partially indicating the choice of the changing process parameters, which facilitates to a large extent continuous flows of the research and manufacturing processes [11].

2.2.1. Classical double crucible and modified multicrucible technologies of soft-glass optical fibers

The FOD at BGW started to manufacture optical fibers with the aid of classical DC process. The FOD of BGW manufactures soft-glass optical fibers with the aid of original technology, which is a modification of the well-known double crucible process. These extensions offer new possibilities and technological tools to the fiber designer. The basic modifications of the DC process are:

- using more crucibles than two (simple multicrucible process – MC) either for precise shaping of the refractive index profile or for obtaining much more complex fiber structures [6],
- introducing divided output nozzles to influence the output glass flow volume, direction, speed, temperature, proportions, *etc.*, [9],

- using inter-crucible zone diaphragms (multicrucible zone diaphragm process – MZD), [11],
- using intra-crucible nozzles (multi-nozzle multicrucible – MNMC).

Some of the modified crucible set-ups are presented in Fig. 4. These modifications (modified multicrucible process – MMC), serving research purposes, give the fiber designer additional possibilities to make unique optical fibers for [12], [13]:

- standard and tailored optical fibers for image-guides, light-guides, optical signal and optical power transmission, sensors, components,
- coherent and noncoherent optical bundle cables,
- optical high power cables,
- ionizing radiation hardened optical fiber cables [12],
- optical fiber couplers of tailored modal and polarization characteristics,
- photonic reciprocal and nonreciprocal components,
- optical fiber Y transformers,
- optical fiber image information coders,
- light aperture transformers,
- sensors: tactile, touch, movement, shift,
- fiberoptic and photonic devices, sub-systems, assemblies and systems.

Tailoring of the fiber properties stems mainly from the possibility of shaping the refractive index profile. It is to be noted that this profile can be not only isotropic but also anisotropic. Structuring of fiber RIP, during the MMC process, is a result of combining different glasses (of different chemical compositions but properly chosen thermal and mechanical characteristics) in one fiber during the high temperature process. The main problem here is the availability of hundreds, if not thousands, of fiberoptics technique relevant glasses. In this respect, the FOD of BGW offers the possibility of building a separate small division, synthesizing this kind of glasses. Certain kinds of high quality, low-loss fiberoptics glasses are synthesized there.

2.3. Research and development

The perspectives of research and application developments in the FOD at Biaglass Co. are connected with extensively developing photonic markets for telecommunication and non-telecommunication oriented products in Poland [13]. The MMC technology gives optical fibers of stable polarization properties and tailored modal characteristics. There are numerous applications of optical fibers with complex refractive index profiles and complex shapes of cores for optical information in-line processing, construction of passive and active filamentary functional components of photonic systems, including integrated optics systems, optical computing ones, and optical communication switching and processing sub-systems. Some of these, tailored fiber based, photonic functional components have more advantageous work characteristics, more convenient values of numerical aperture, favourable energetic properties, shape of RIP and modal characteristics [14], [15].

The FOD of Biaglass Co. carries out research on fiberoptic relevant, non-silica based, optical quality, low-loss, very light and very heavy glasses. Some research is also done in the area of non-oxide glasses for fiberoptics. The MMD technology and,

similar to it, an extrusion technology with auxiliary (augmented, adiabatic) nozzle heating makes it possible to draw optical fibers from halogenide, heavy oxide, non-silica oxide, and chalcogenide glasses. The latter technological method of fiber manufacturing from novel materials is now researched in the FOD at BGW. This method (EXTRNH) uses nearly the same equipment as the MMC, but slightly pressurized crucibles and more complex heating zones along the furnace vertical axis. These fibers, as is well known, work in near and middle infrared systems like industrial overheating monitoring, IR transmission, remote detection and imaging, etc. In optical transmission or detection circuits, they cooperate with IR active components.

2.4. Education and continuous engineering training

The FOD of Biaglass Co. has been organizing a periodical conference on *Non-telecommunication Applications of Optical Fibers*, since 1983. Now this conference is a continuation of Jabłonna National Symposium on *Optical Fibers and Their Applications*. Most people active in optical fiber research and engineering in Poland usually participate in this conference. The FOD issues the volumes of materials from this periodic conference and distributes them among all participants and all optoelectronics and fiberoptics laboratories throughout the country.

The FOD is also very active in the domain of education. It cooperates with several universities in this domain, like UMCS and WUT. Recently the FOD has taken part in the EU sponsored Joint European Project (JEP) concerning *Education in Optoelectronics*. Several optoelectronics students were exchanged between leading European laboratories during this program. Some of these students may start their first work, after this international fellowship, at FOD or TUB. Several valuable M.Sc. theses in optical fiber technology resulted from this co-operation. In addition, a program has been initiated by FOD for an exchange of photonics students between TUB, UMCS and WUT universities.

2.5. Manufacturing

The manufacturing facility at the FOD of BGW has a proper cleanliness class. The fibers are manufactured from the highest purity materials. As is well known, the crucible process, in the simplest solution, is an open one, and requires careful protection against the dust. The measures taken to ensure proper clean-room conditions resulted in decrease of the soft-glass optical fiber losses typically below 0.1 dB/m in the visible spectrum. These losses originate not from the technological process but from the level of purity of output raw materials. Further purification of the output materials is, of course, still possible, but increases considerably the overall costs of the process and, thus, the resulting product. The lowest losses of fibers are obtained from the most pure output materials.

The losses of the order of 0.1 dB/m, for multicomponent glass optical fibers, are quite a good result for typical applications. This value is, however, a confining threshold for many non-telecommunication applications (*i.e.*, not embracing long haul communications). Off-the-shelf availability of low-loss, very low-cost, soft-glass optical

fibers, which are mechanically reliable, and relevant for the cabling procedures, opens for the FOD at Biaglass Co. new considerable markets of short distance data transmission systems. Numerous applications require reliable high rate transmission over distance of a few meters, a few tens of meters, exceptionally around a hundred meters. For example, USB PC technique may be realized in optical fiber technology, as well as RS and GPIB ones. These PC and industrial instrumentation standards will be more frequently realized in cheap and easily available optical technology. This techniques assures, in the simplest way, resistance to interference in adverse environment and lifts any confinements on bit rate and distance product, which hold for standard solutions.

Today, the manufacturing profile of FOD at Biaglass embraces the following optical fiber bundle cables:

- lengths up to several meters,
- standard cables, divided cables,
- optical aperture up to 20 cm and more; different shapes of optical apertures, multiple apertures,
- optical transmission from 0.3 up to 1.6 μm ,
- optical attenuation in the range from 0.1 to 1 dB/m depending on application,
- diameter of single fiber in the bundle cable 5 – 100 μm depending on minimal required bending radius, optical and numerical apertures,
- numerical aperture typically 0.12 – 0.8,
- package (plastic or metal), for internal or external applications, hardened and armoured,
- connectors: customized, armoured, miniature, standard, SMA, plastic, *etc.*,
- special optical cables, such as radiation hardened cables, underwater cables, chemical environment (base-acid interference) hardened cables, mechanical impact hardened cables, high-pressure throughput cables, high temperature (cooled) cables.

The FOD offers also single optical fibers for photonic functional components. Some of these fibers were presented on photographs (Figs. 11 – 15). The fibers can be manufactured from customized materials and according to customized design. They can have shaped end tips (Fig. 16).

The FOD offers customized image-guides, stiff and flexible. Coherent components of fiber microoptics (plates, rods, lenses, beam expanders, cones, *etc.*), are available. The components can be application optimized with regard to the kind of multicomponent glass used for manufacturing. The parameters that can be customized include: spectral transmission, sensitivity to external harmful reactions, *etc.* Service of image-guides is available at FOD. The laboratory designs, researches, and manufactures customized fiberoptic imaging systems on demand.

The FOD undertakes also customized system work on optical fiber sensors. Some families of amplitude sensors, especially for chemical analysis, environmental monitoring, will be soon available from stock.

The FOD of Biaglass Co. is now a supplier of:

- cables and fibers,
- tooling and kits,

- patchcords and pigtails,
- structured cabling systems,
- test and measurements,
- passive components,
- fiberoptic lighting,
- fiberoptic image transmission,
- connectors and splicing systems,
- technical books and training.

2.6. Fiberoptic services

The FOD of Biaglass Co. maintains close relations with its customers and cooperating research laboratories. FOD offers a broad spectrum of services connected with its research and manufacturing activities in the domain of optical fiber technology and fiberoptics. Among others, it services its products. The FOD also undertakes the service of other fiberoptics equipment.

3. Recent and planned research on optical fibers and components at Fiber Optics Department of Biaglass Co.

The FOD is active in nearly all current trends of soft-glass optical fiber research. Several main research directions can be distinguished today at the FOD of Biaglass Co. These recent endeavours and efforts have been [16]:

- novel glasses for fiberoptic technology,
- novel fiberoptic technologies and fiber structures for photonic functional devices,
- optical fiber sensors,
- photonic functional systems,
- education in photonics.

3.1. Education in photonics

To address the needs of education the FOD prepares a special fiberoptic kit. It is a versatile self-contained learning tool. The assumption is for it to be interactive. It is meant to give a user an understanding of the fundamentals of fiberoptics. This understanding is hoped to be achieved through a series of own practical experiments done by the student. The experiments in the kit may embrace light travelling along the bends in optical fiber, coloured light transmission in fiber, transmission through a gap between fibers, divergence of light from fiber, LED coupling with fiber, PD coupling with fiber and coupling efficiency, fiberoptic reflection sensor, fiberoptic transmission sensor, fiber position sensor, fiber bending induced loss, connecting optical fibers, measuring loss in the fiber, *etc.*

3.2. Novel optical fiber structures

Novel fiber structures are used for some functional purposes in optical fiber microoptics systems. The research on novel optical fiber structures for photonic

functional devices embraces, among others:

- optical fiber micro-optics,
- multicore optical fibers for coupling, switching, looping and signal processing,
- micro-optics of single mode fiber tip, and device coupling,
- optical computing and photonic switching,
- optical fiber and photonic sensors.

3.3. Soft-glass optical fiber sensors

Perhaps, still the biggest research potential is in the domain of optical fiber sensors and their practical applications. Here at FOD, we are interested in optical fiber sensors requiring tailored specialty optical fibers. Such sensor oriented fibers can be technologically sensitized or immunized against particular reactions for a particular application. Technological tailoring of fiber properties is a complex problem embracing not only fiber material but also its structure, proportions, values of particular parameters, *etc.*

Several groups of sensors are of interest at FOD because of potential applications at FOD partners. One of the groups contains optical fiber bundle cables manufactured here and integrated on the site with sensing head. These kinds of sensors are mostly amplitude ones, transmissive or reflective, sometimes polarizing. This integration of cable and fiber sensor is done either routinely or according to the customer's design. This group of sensors is tradable, while most of the other groups are not yet.

One of the most interesting groups of optical fiber sensors is that for chemical analysis. The FOD co-operates with several research and application groups active in this kind of sensors. This volume contains description of a few of these sensors, where the optical fibers were manufactured by FOD of Biaglass Co. Some of these sensor principles are presented in Fig. 6.

Another group of sensors is directly connected with the research and applications of tailored optical fibers. This group is potentially much richer as it contains, apart from the amplitude sensors, also other types such as: phase, evanescent and tunneling waves, resonant, polarizing, interference, coupling, coherent, selective, anisotropic, *etc.*

3.4. HB, anisotropic and isotropic optical fibers

Single-mode polarization maintaining optical fibers are manufactured during MMC process. A few examples are presented in Figs. 10, 11. Different shapes of the stress regions allow us to shape subtly the polarizing properties of fiber components.

Other types of tailored core optical fibers are elliptical core and strip core optical fibers. These fibers are manufactured with different ellipticities, different dimensions, and refractive properties of the strip. There are several basic geometries possible of elliptical multicore optical fibers. The longer axes of the core ellipses can be parallel, or the shorter axes of the core ellipses can be parallel. The longer axes can be made perpendicular or, in special case, assume an arbitrary angle.

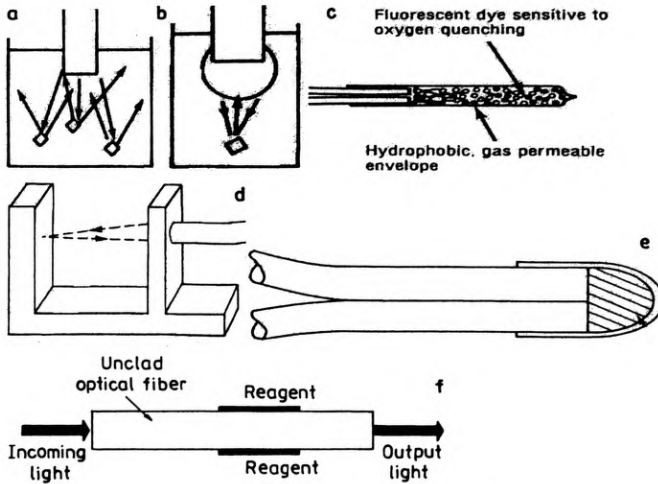

Fig. 6. Chosen examples of optical fiber sensors for chemical analysis. Unfocused (a) and focused (b) remote fiberoptic fluorimetry probes, fiberoptic fluorescent probe (c), fiberoptic gas/smoke sensor (d), reflective fiberoptic sensor using immobilized reagent for absorption based sensing (e), transmissive fiberoptic sensor with reagent adjacent to the core, using evanescent waves interaction and absorption (f)

3.5. Multicore single-mode and multimode soft-glass optical fibers

Multicore single-mode and multimode optical fibers are manufactured during the MMC process. The research literature accepted only twin-core single-mode optical fibers (for example, for polarization maintaining transmission), while the others are treated as exotic ones, sometimes useful for novel photonic sensors. Multicore optical fibers are researched by us for novel functional components of fiber microoptics. Photonic switching systems are constructed based on optical fibers with linearly arranged single-mode cores.

3.6. Multiclad optical fibers

Multiclad MMC optical fibers, with enhanced diffusion during the hot stage of the pulling process, exhibit very complex shapes of RIPs. These optical fibers, in short lengths, have recently been used for multi-point distributed "hot spot" transmissive sensors. These fibers are also researched for photonic components.

3.7. Optical fiber microoptics

Some kinds of prospective photonic sensors require complex fiber ending (tips). The research on fiber tips led us to the construction of a new family of sensors based on tailored and engineered fiber tip. The MMC technology gives fibers which are easier to be processed mechanically or chemically to obtain desired tip properties.

Gradient optical fiber imaging systems find professional applications in certain kinds of imaging techniques. The research in this domain supports these techniques.

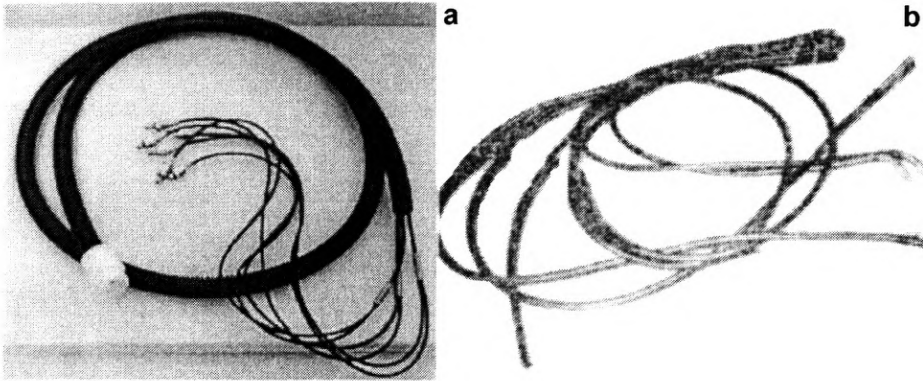

Fig. 7. **a** – integrated multichannel optical fiber sensor based on Biaglass optical cable with SMA connectors. This sensor is described in detail in the other paper in this volume, concerning optical fiber telemetric system for environmental applications. **b** – armored multichannel optical cable for fire alarm system in wooden chops high-temperature drying system. The individual optical cable heads (which are high temperature resistant) observe several places distributed on the circumference and along the huge drying and rotating steel pipe. The optical signals, which are signs of flame outbreaks, are collected to a single aperture. The aperture is coupled with large area photodiode and next through some electronics to the alarm and automated fire extinguishing system

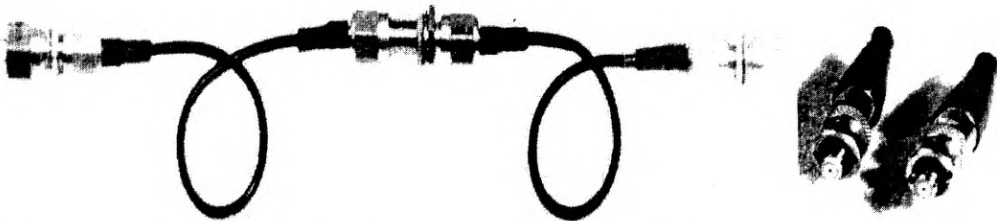

Fig. 8. Optical fiber cable link with connectors made at the FOD of Biaglass Co.

3.8. Fiberoptic components and systems

The research on the complete photonic systems is carried out mainly in the area of monitoring industrial systems, like fire alarm ones and in the area of optical fiber sensors. Components for these systems are also investigated (Figs. 7–21).

3.9. Examples of optical fibers, fiberoptic components and devices manufactured and researched at Fiberoptic Laboratory of Biaglass Co.

Below we present some examples of research and manufacturing work carried out recently at the Fiberoptic Laboratory of Biaglass Co. Some of these research results are also presented, in more extended way, in other papers [13], [15], [16].

3.9.1. Research on diffusion processes in MMC optical fibers

The input glasses and diffusion conditions during the process have the most important influence on the gradient RIP of MMC. Ion exchange processes are active

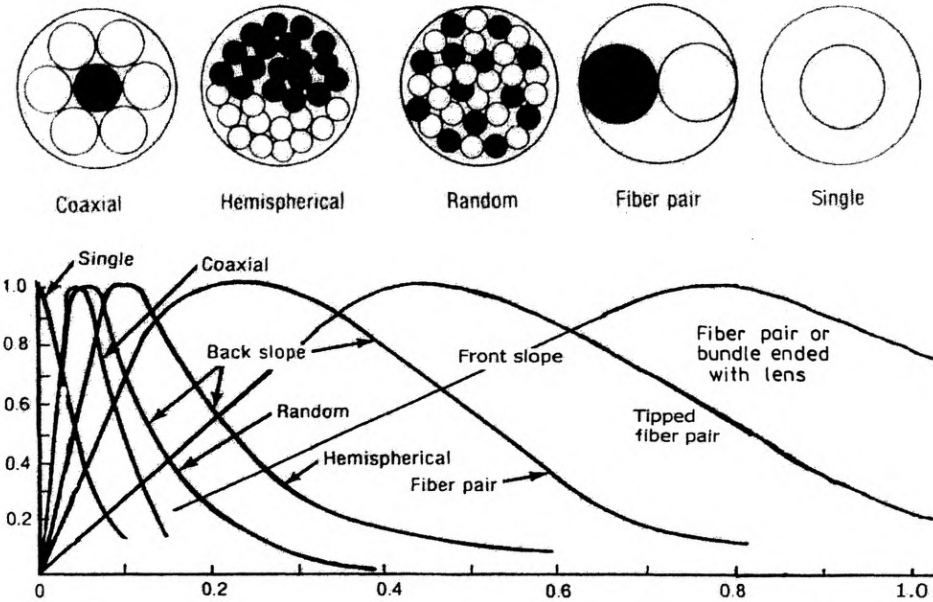

Fig. 9. Reflective fiberoptic sensors response curves for various fiber/bundle configurations. These configurations are performed on customer's demand at FOD of Biaglass Co. The range of applications of these sensors vary from tactile to vibrometers, from medical to medical and measurement (like vibrating components characterization)

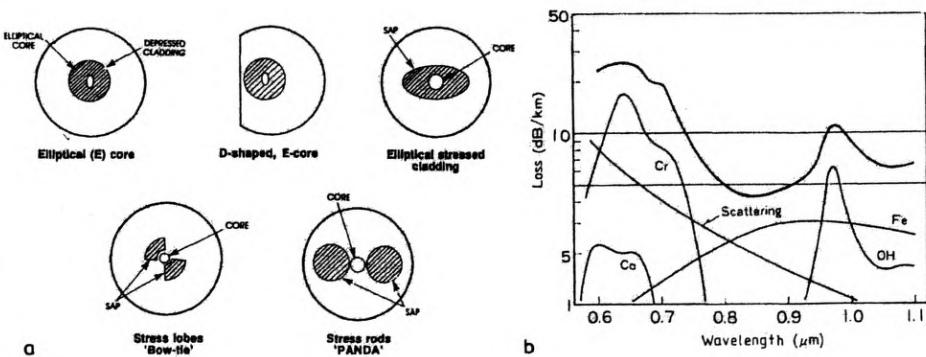

Fig. 10. Chosen ideas of core and stress applying agents construction for highly birefringent optical fibers (a), and soft-glass fiber losses with some of their major components (b)

between the glasses of core and successive claddings of multicladd fiber structure. The efficiency of glass ion exchange depends on diffusion constants D of modifying ions, temperature of the process and, particularly, on distribution of the temperature in the region of fiber formation, time of the hot stage of the process (fiber pulling speed, length of fiber formation region $td = Ld/V$). Ion distributions, participating in the diffusion processes, were measured in the Institute of Physics, PAN, Roentgen Laboratory, with the aid of IXA-50A electron microprobe. Comparing the ion concentration profiles with the RIP (measured by transverse interferometric method)

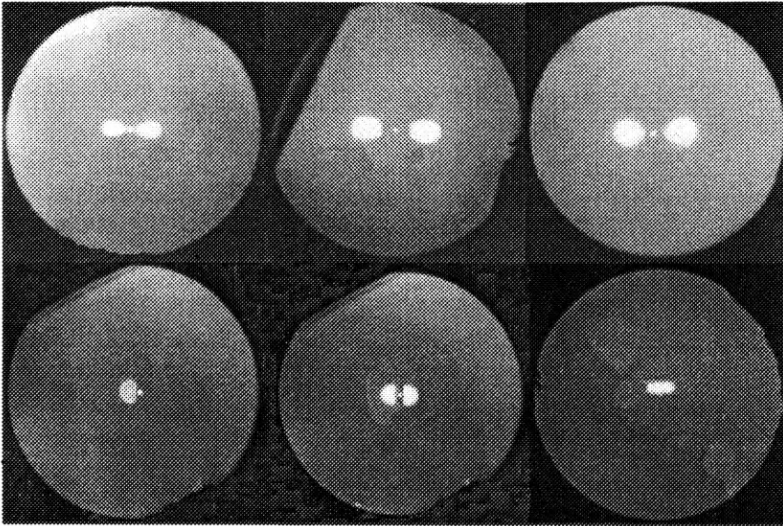

Fig. 11. Cross-sections of polarization maintaining fibers obtained in soft-glass MMC process. The BH fibers presented here are single mode with the following dimensions: fiber diameter around 100 μm , core diameter 4–6 μm . The MMC technology makes it possible to tailor strictly designed shapes of the stress applying lobes

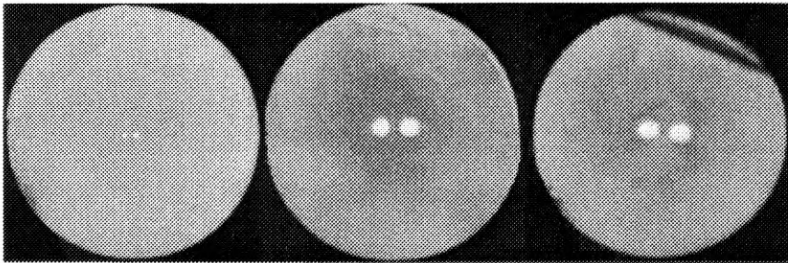

Fig. 12. Soft-glass MMC twin core single-mode optical fibers with circular and elliptical cores. The dimensions of the fibers can be matched to the prevailing standards in optical fiber transmission standards for optimal coupling and system relevance

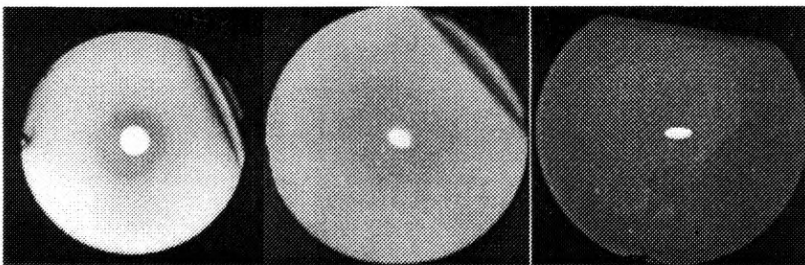

Fig. 13. Soft-glass MMC optical fibers with cylindrical (depressed cladding) and elliptical cores. Various degrees of ellipticity are visible in these fibers

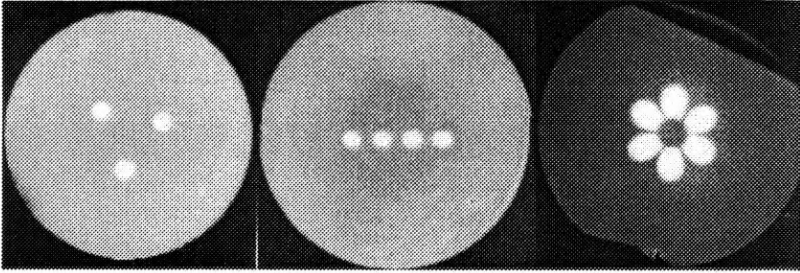

Fig. 14. Soft-glass, MMC, multicore, optical fibers with evenly spaced three cylindrical cores, and linearly arranged four cylindrical single-mode cores and axially arranged multi-elliptical core

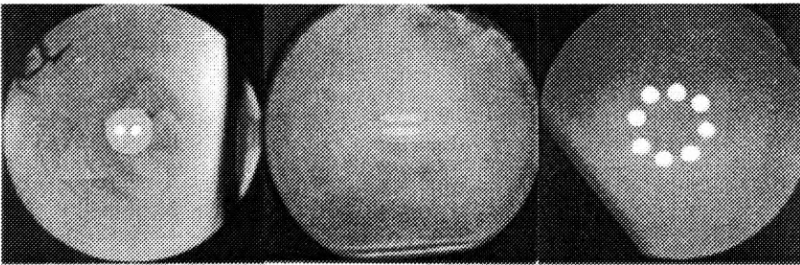

Fig. 15. Soft-glass, MMC multicore, optical fibers. Twin-elliptical core OF is a novel structure here

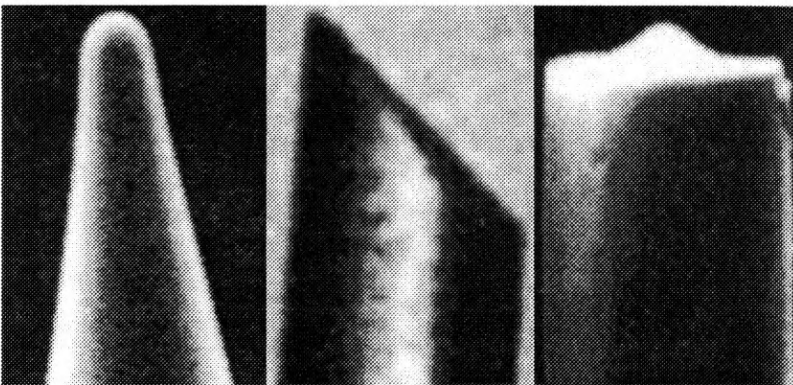

Fig. 16. Soft-glass MMC optical fibers with different, application oriented, endings (tips)

the following conclusions were drawn concerning the MMC process (an illustration for this is Fig. 18):

- The concentration profiles of Na^+ and K^+ ions are in agreement only with the RIP measured by interference method for glasses not containing heavier glass forming ions.

- Migration of Pb^{2+} , Ba^{2+} , La^{3+} ions visibly influences the RIP of the fiber. These ions have constants D considerably lower than the alkaline ions, but at particular technological conditions, these differences can be substantially diminished.

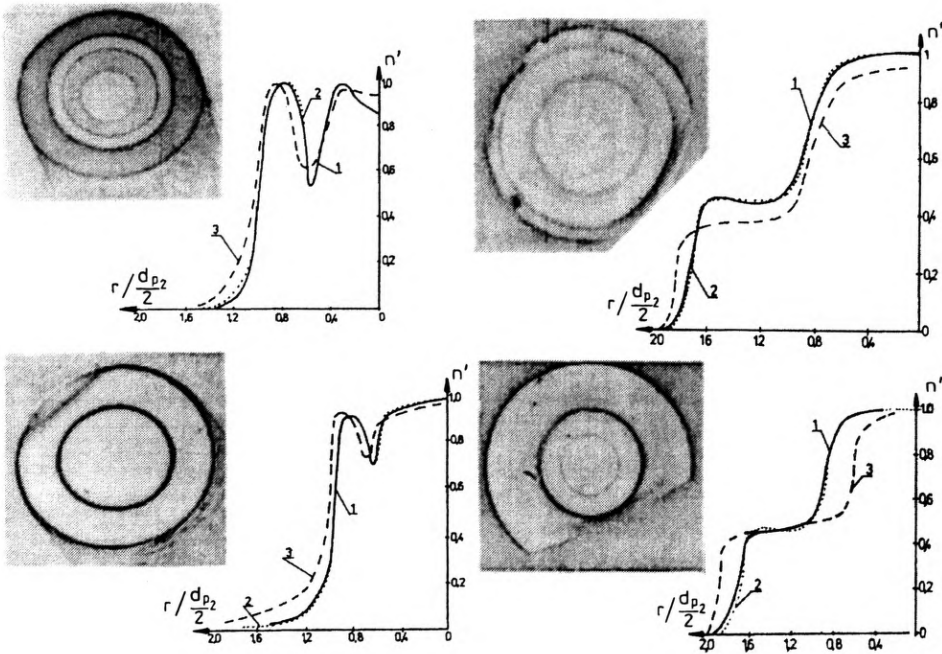

Fig. 17. Soft-glass MMC multicladd optical fibers of complex RIPs. It is nearly impossible to design and manufacture optical fibers with more complex RIPs than the MMC process ($d_{p_2}/2$ – radius of second cladding, $n(r) = n(r)/n_{\max}$ – normalized value of refractive index)

– Increasing of the process temperature does not cause a straight proportional increase of the diffusion depth. Increasing experimentally the temperature of the process for fibers in Fig. 18 by 100 °C caused slight shrinking of the area of ion exchange but increased slightly local exchanged ion concentration. This curious effect is probably due to quite a big change in the effective time of ion exchange. This additional 100 °C, in the critical temperature region of the glasses presented in Fig. 18, is a lot, and the abrupt drop of viscosity results in an increase of fiber pulling speed. Formation process of the MMC optical fibers, for particular glass system, can be done only at optimal temperature, and only slight deviations are possible. These possible deviations can be used effectively for diffusion process optimization.

– RIPs of MMC optical fibers, pulled at the end of the process, are different from the ones from the beginning and middle stages of the process. This stems from the changing crucible-nozzle geometry, with change of glass pressures.

– The concentration profiles show that the MMC method allows the combining of glasses of considerably different parameters. This concerns especially mechanical parameters. Destroying level of mechanical stresses frozen in the fiber was not observed even in fibers composed of glasses, where the difference of thermal expansion coefficients was around 10%. This was not realizable in DC optical fibers.

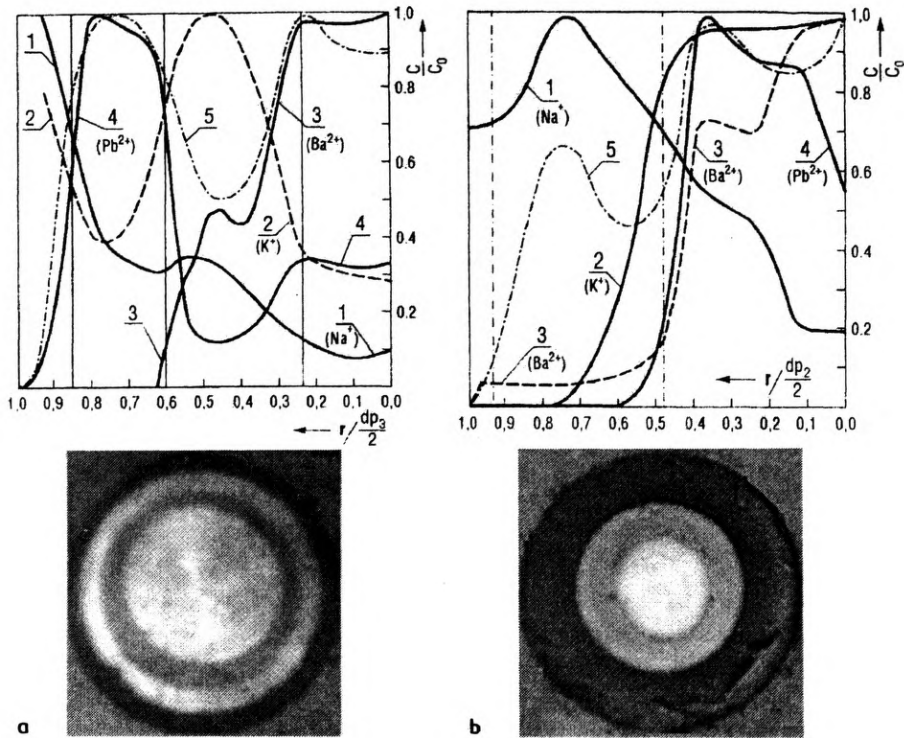

Fig. 18. Glass ion diffusion processes in MMC multicladd optical fibers. **a** – four crucible optical fiber made of BaF8-BaLF5-F2-S8 glasses. $T = 1000\text{ }^{\circ}\text{C}$. **b** – three crucible optical fiber glasses BaLF1-BaLF2-S4, $L(r-p_1) = 4\text{ mm}$, $L(p_1-p_2) = 20\text{ mm}$, $T = 1050\text{ }^{\circ}\text{C}$ (pulling process temperature (internozzle region)), 1 – Na^+ ion transverse distribution, 2 – K^+ , 3 – Ba^{2+} , 4 – Pb^{2+} , 5 – RIP measured with interference method. p_1 – first cladding, p_2 – second cladding, p_3 – third cladding, d – diameter, r – fiber radius, L – internozzle distance, C – mobile ion concentration, C_0 – initial concentration of exchanging ions, C/C_0 – normalized concentration, d_{p_2} – second cladding diameter, d_{p_3} – third cladding diameter, $L(r-p_1)$ – internozzle distance for core and first cladding crucibles

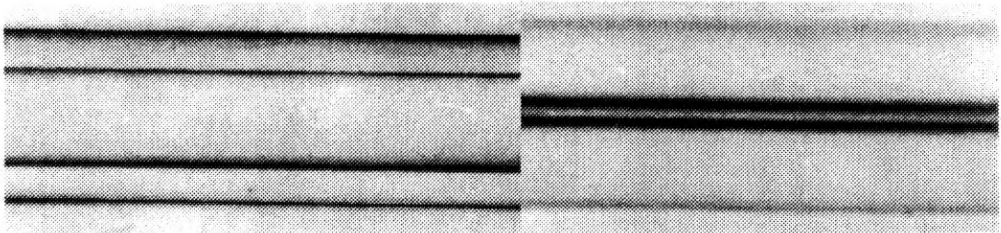

Fig. 19. Longitudinal transverse microscope photographs of MMC multimode and single-mode optical fibers in immersion fluid. The photographs show quite a good homogeneity of MMC optical fibers and nearly ideal optical boundary between the core and cladding. The quality of fiber depends on its structure as seen in this photograph

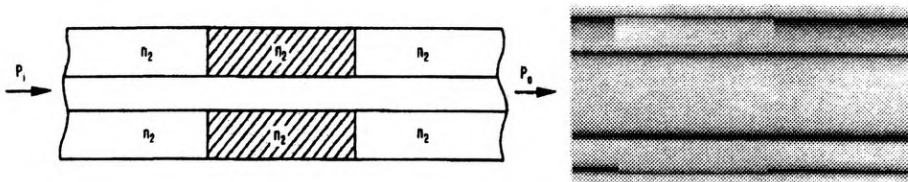

Fig. 20. Intrinsic fiber optic sensor using local refractive index change in a continuous single multimode MMC optical fiber. General idea of optical fiber "hot spot" sensor for multi-point distributed sensing and practical realization of the fiber at Biaglass Fiber Optics Laboratory. Here, at the hot spot, the fiber has different value of NA, but the idea holds also for other fiber parameters. The hot spot can be made either by local chemical diffusion or by fusing in a length of the sensing fiber

3.9.2. Research on core shape imaging during the MMC process

MMC process gives tailored optical fibers. In particular, the refractive topology of fiber cross-section is one of the main design subjects. The parameters influencing the fiber manufacturing MMC process are: temperature in the furnace, shapes of nozzles, location of crucible pile against the furnace output, *etc.* Each part of molten glass stream (forming a fiber) is subject to dynamic action of the following forces: viscosity, surface tension, and gravitation. The first two of these forces are functions of temperature and nozzle geometry (absolute and relative diameters, shapes, presence of corners, narrow and broad parts, *etc.*). The relative influence of the gravitational (and additional pulling force) factor depends on the value of the first two factors. The role of gravitational factor increases with the decrease in glass viscosity (increase of temperature and bigger nozzle diameters). In lower temperatures, the viscosity related forces dominate over big value of surface stress forces. The fiber pulled in such conditions should image the core shape (defined by nozzle geometry) quite well. This is under the assumption that this shape is not too complex, *i.e.*, has comparatively not too thin places. Too big viscosity will not allow the glass to flow at equal speed in all parts of the nozzle. The flow velocity will be smaller in narrower parts of the crucible nozzle. Thus, the core imaging will be distorted proportionally to the relative volume flow in different parts of the nozzle.

In order to image the fiber core perfectly, the MMC process should be realized at higher temperatures. Decreased viscosity allows the glass to flow through complex nozzle shapes. Too low viscosity decreases the ability of the glass to image the core perfectly. At very high temperatures, the viscosity decreases for nearly constant value of surface tension. In reality, when the temperature increases by 100 °C, the surface tension decreases by 1.0–1.5%. Increasing role of surface tension causes the rounding of too small details in the nozzles and the imaging worsens. Thus, the core imaging is the best for some optimal temperature chosen individually for particular sets of glasses. The number of parameters influencing this temperature is quite large: all individual glass characteristics for the fiber, differential characteristics, nozzle shapes, *etc.* The best way to determine the value of optimal core imaging temperature is technological experiment.

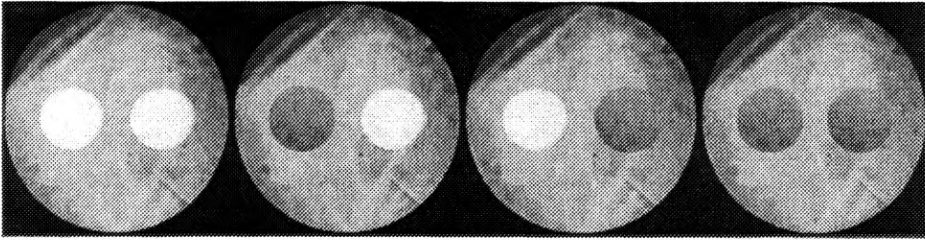

Fig. 21. Optical power switching in a multimode twin-core MMC optical fiber. Analogous to TDM, FDM and WDM this process can be called a Core Division Multiplexing (CDM). Here, optical power switching was obtained by applying transverse stress to a particular length of the MMC fiber. Fiber external diameter $45\ \mu\text{m}$, core diameter around $14\ \mu\text{m}$, $\text{NA} = 0.25$. The CDM research evokes great expectancies, since it potentially allows us to realize all optical, all fiber compatible, and all intrinsic photonic switching. It is assumed in this research that proper choice of multicore optical fiber component materials will lead to active electro-optical device totally hidden in a single fiber of standard telecommunication dimension (external). More complex structures can also be predicted

The core imaging quality is also influenced by the shape of bottom part of the crucibles. The MMC process at FOD uses three kinds of pure silica crucibles with flat, spherical and parabolic bottoms. The parabolic bottom lobes were quite steep in the crucible. The comparison experiments were conducted in the same laboratory conditions, *i.e.*, the same glasses, temperatures, nozzle shapes, nozzle geometry, *etc.* The flat bottom crucibles were the best in core imaging for the lower part of the allowable process temperature range. The parabolic bottom crucibles were the worst, while spherical ones were in the middle. For upper part of allowable process temperature range, the differences between crucible bottoms were non-distinguishable. However, at these temperatures the imaging was poor. For the temperatures around the optimum, the differences in imaging were quite interesting. These processes are a subject of research for different glass sets and different shapes and geometry of nozzles.

The core imaging quality is also influenced to some extent by the glass pressures in crucibles. Glass pressure at the nozzle results from viscous liquid pressure of certain height confined in a crucible. Initially it was assumed that a big differential value of glass pressures between core and cladding crucibles and nozzles will give a better core imaging. The experimental result showed something quite different for glasses of similar viscosities. High differential value of pressure increases the hydrostatic force. The volume flow of core glass is bigger, at small viscosity, proportionally in all places of the nozzle aperture. The change of the proportions of core and claddings is the only result of this process. This change is in a sense of geometrical similarity and not imaging of subtle details of shape. The analysis of forces at the nozzle aperture output allows one to say that hydrostatic pressure lowers spuriously the value of viscosity force, which at constant value of surface strength leads to poorer core imaging.

3.9.3. Research on twin core optical fibers

Twin core optical fibers (TCOF) have been subject of research for a few reasons. The TCOF can potentially realize the following functions:

- support single polarization transmission,
- couple fibers and photonic devices,
- switch optical power between cores,
- make photonic functional devices, like modal and spectral filters for WDM, optical insulators, nonreciprocal photonic components,
- make novel active devices, when manufactured of active materials,
- make twin core based family of sensors.

A single mode TCOF is one of the early alternatives for single polarization transmission in an optical fiber. The perpendicular components of the fundamental mode can potentially be separated among the closely adjacent single-mode cores. These selective characteristics of TCOF can also be used for other functions, like building selective filters, bent filters, TCOF tapers, taps, couplers, power and signal switches, sensors, *etc.*

Twin core sensor, for distributed multi-point sensing, is one of our concerns. The idea of this kind of sensing is presented in Fig. 20. The sensing “hot spots” are distributed along the continuous length of optical fiber.

The most intriguing feature of a twin core single-mode optical fiber (in particular) and multicore optical fiber (in general) is the potential possibility to realize a transmission with CDM.

3.9.4. Research on multicladd MMC optical fibers

The multicladd MMC optical fibers are researched for photonic functional devices like selective filters, couplers and sensors.

3.9.5. Research on MMC fiber microoptics

An engineered fiber optic tip can be used for various photonic devices such as: couplers, power dividers, photonic probes, sensors. Fiber microoptics embraces also fused imaging micro-plates, conical coherent micro-components and a considerable number of other functional devices.

3.9.6. Research on MMC optical fiber sensors

The MMC optical fibers can be optimized for applications as photonic sensors. MMC process and other glass technology processes available at the FOD allow fiber sensitization towards the measurand and simultaneously allow desensitization against harmful interference. Major part of this research is optical fiber material engineering and design. The fibers contain then additional sensitizing or desensitizing layers as additional external or internal claddings. Some of these claddings can also play optical roles at the same time.

3.9.7. Research on fiberoptics based functional systems and applications

The main aim of the Fiberoptics Laboratory at the Biaglass Co. is to advance the technologies which may be turned to the products of the manufacturing part of the

FOD. However, the researchers there, due to the close cooperation with TUB, UMCS and WUT, are also interested in total homogeneous photonic functional systems for steering, illumination, imaging, telemetry, monitoring and other similar functions. These systems have to use as many of the FOD products as possible. A lot of TUB students take part in this research making their M.Sc. and in the future Ph.D. theses in cooperation between FOD, TUB, WUT and UMCS.

Some of the examples of research on photonic based system applications are: local area telemetric fiberoptic system, fiberoptic based city streets illumination control system, fiberoptic systems in adverse environments, photonics technology based natural environment monitoring station, fiberoptic functional components in system applications, short length fiberoptic digital bus for data distribution and processing, ionizing radiation hardening of fiberoptic systems, high temperature hardening of fiberoptic systems, vibration and mechanical shock hardening of fiberoptic systems, industrial applications of fiberoptic systems, fiberoptic systems for smart vehicles, building, vessels, *etc.*, complex path (multiple path) image distribution fiberoptic systems, applications of optical fiber systems in future computers, photonic processors, and others.

4. Conclusions

Over the last twenty years of research and manufacturing activity in the field of fiberoptic photonics in Poland, the Fiberoptic Department of BGW and Biaglass Co. established itself as one of the leading technological centers. The group of researchers and manufacturers, associated with the Fiberoptic Department of BGW and Biaglass Co., has gathered quite a large research and manufacturing experience, during this period.

Now, the Biaglass Co. offers a number of off-the-shelf fiberoptics high quality products mainly to the domestic photonic market. This market consists of several main niches:

- fiberoptic medical equipment,
- fiberoptic industrial equipment,
- standard, customized and tailored optical fibers and cables,
- optical fiber sensors,
- optical fiber functional components for research.

All technological and optical materials, glass samples, optical fibers, components, devices, sub-systems and systems presented in this digest are available, either on customary basis or in small samples for research. Any suggestions from customers, research co-workers and students about research co-operation on tailored optical fibers, fiberoptics, photonic technologies, measurement techniques, components, devices and systems, being in relevance to the above-presented scope, are highly appreciated by the authors of this paper.

References

- [1] Proc. First National Symposium on *Optical Fibers and Their Applications*, (in Polish), [Ed.] B. Mroziwicz, Jabłonna near Warsaw, February 16–17, 1976, PWN, Warsaw 1976, pp. 1–518.
- [2] DOROSZ J., KUCHARSKI J., BOŻYK M., JARMOC J., *Step index optical fibers from lead glass*, [In] II National Symposium on *Optical Fibers and Their Applications*, (in Polish), [Eds.] A. Smoliński, R. Romaniuk, Jabłonna near Warsaw, February 13–15, 1979, Vol. II, pp. 32-37.
- [3] DOROSZ J., *Electronics* (in Polish), **23** (1982), 30.
- [4] DOROSZ J., ROMANIUK R., *Triple crucible and quadruple crucible technology of optical fibers* (in Polish), Proc. III National Symposium on *Optical Fibers and Their Applications*, (Eds.) A. Smoliński, R. Romaniuk, Jabłonna, February 16–18, 1983, Vol. I, pp. 29–41.
- [5] DOROSZ J., ROMANIUK R., *Technology of tailored optical fibers*, (in Polish), [In] III National Symposium on *Optical Fibers and Their Applications*, Jabłonna, February 16–18, 1983, Vol. I, pp. 42–59.
- [6] DOROSZ J., ROMANIUK R., *Glass and Ceramics* (in Polish), **34** (1983), 109.
- [7] LEŚ W., DOROSZ J., ROMANIUK R., *Glass and Ceramics* (in Polish), **34** (1983), 145.
- [8] ROMANIUK R., DOROSZ J., *Telecommunication Review* (in Polish), **60** (1985), 9.
- [9] ROMANIUK R., DOROSZ J., Proc. SPIE **670** (1986), 12.
- [10] ROMANIUK R., DOROSZ J., Proc. SPIE **722** (1986), 117.
- [11] ROMANIUK R., DOROSZ J., Proc. SPIE **798** (1987), 316.
- [12] ROMANIUK R., *Fiber Optics in the Adverse Industrial Environment*, Tutorial Short Course Notes Booklet, Fiber-Lase, Boston, MA, USA, 9.09.1988, Printed by SPIE.
- [13] ROMANIUK R. S., (Guest Editor), *Int. J. Optoelectron.* (special issue), **4** (1989), Taylor and Francis, London, New York.
- [14] DOROSZ J., *Crucible technology of multicore fibers*, Research Dissertations of Technical University of Białystok, Vol. 29, Białystok 1995 (in Polish, contains English summary).
- [15] DOROSZ J., *Theoretical and practical problems of multicore fiber optic technology*, Research Dissertations of Technical University of Białystok, Vol. 41, Białystok 1997 (in Polish, contains English summary).
- [16] DOROSZ J., [Ed.], Proc. 1998 Białowieża Conf. on *Optical Fibers and Their Applications* (in Polish), January 22–24, 1998, Białowieża, Poland, Technical University of Białystok Sci. Eds., Białystok 1998, Vol. I, II.

Received October 19, 1998