

Thermally stimulated currents in silica xerogels with temperature gradient

HENRYK SODOLSKI, WŁADYSŁAW TOMASZEWICZ

Faculty of Applied Physics and Mathematics, Technical University of Gdańsk, ul. G. Narutowicza 11/12, 80-952 Gdańsk, Poland.

The paper gives results obtained by application of the method of thermally stimulated depolarization (TSD) to investigate dipole relaxation in SiO_2 xerogels. The presence of a strong temperature gradient in the sample has been revealed during measurements of the TSD current. The paper describes the method of determination of activation energy W , initial polarization P_0 and factor τ_0 for the dipole relaxation processes under investigation. It has been shown that the modified TSD method is a sensitive tool for the investigation of changes taking place in the peripheral molecular layer on the surface of pores in SiO_2 xerogels.

1. Introduction

The thermally activated current spectroscopy is a highly sensitive technique for the investigation of electrically active centres (dipoles, pseudodipoles or space charges) in semiconductors and dielectrics [1]. The method used in this work, based on measurement of thermally stimulated depolarization current (TSDC), is one of the methods applied in thermally activated current spectroscopy [1]–[3].

Many experimental results and theoretical elaborations concerning TSDC were obtained for materials and physical conditions which allow one to assume uniform temperature distribution in the samples being investigated. This condition is not fulfilled for materials of very low thermal conductivity or for samples which cannot be formed into films.

In particular, a strong non-uniform temperature distribution occurs in samples of silica xerogels (SiO_2) obtained by the sol-gel method [4]. A very low thermal conductivity of SiO_2 xerogels (particularly when they are investigated in vacuum) results from the high porosity of this material.

The usefulness of spectroscopic investigations of silica xerogels results from the fact that the electrical properties of these xerogels depend on the molecular state of the internal surface and polarization phenomena in the pores [5].

Up to now, the influence of non-uniform temperature distribution on thermally stimulated depolarization current, caused by dipole relaxation [6]–[8] or by space charge relaxation [7], [9]–[11], has been investigated in few papers. In all papers (excluding [8]) the authors assume a constant temperature gradient in samples investigated by the TSD method. This does not correspond to the physical reality.

Only paper [8] proposed a theoretical description of TSDC for dipole relaxation with single relaxation time which takes into account a real temperature distribution.

Preliminary results of TSDC spectra for pure and ion-doped (RbCl) silica xerogels have been presented in paper [12]. The results described in this paper are only qualitative in character and do not take into account the gradient of temperature in the sample. The aim of the present paper is to present experimental dipole TSDC spectra obtained for SiO₂ xerogels. The analysis of the spectra includes the temperature gradient in the samples examined. Calculations of the activation energy of relaxation process under investigation are based on the theoretical results proposed in [8].

2. Experimental

2.1. Materials

In carrying out our measurements of TSDC, samples of SiO₂ xerogel obtained by the sol-gel procedure [5] have been examined. The sol components were used in the following molar ratio: Si(OC₂H₅):HCl:H₂O:RbCl = 1:0.59:24.6:x, where $x = 0$ or 0.01 mole with respect to Si(OC₂H₅). A small amount of the RbCl dopant caused a decrease of the specific surface of the xerogel and an increase in its electrical conductivity by about one order of magnitude [12]. The heat rates applied in our experiment were $\beta_1 = 2$ K/min. or $\beta_1 = 4$ K/min. Temperature was changed within the range 290–570 K. The surface of the gold electrodes on the sample was $s \approx 0.1$ cm². The thickness was within the range of $L = (0.5-0.6)$ mm.

2.2. Measurements of TSDC with temperature gradient

Measurements of TSDC were performed using a system with linearly increasing temperature. A fragment of the system is shown in Fig. 1. The heater was supplied by alternating current and operated by a microprocessor, thus giving us the possibility to adjust the heating rate and precisely control the temperature increase. The mica spacer and both surfaces of the sample had gold vacuum-evaporated electrodes which allowed us to measure polarization and depolarization currents.

Two identical samples were used for each experiment. One of them served for measurement at temperatures $T_1(t) = T(0, t)$ on the surface of sample in contact with the heater and $T_2(t) = T(L, t)$, where L is the sample thickness (Fig. 1). The other was used for the TSD current measurement. The measurements were conducted in dynamic vacuum, with pressure $p \approx 4 \cdot 10^{-3}$ Pa.

In Figure 2a, an example is shown of a typical experimental course of temperatures: $T_1(t)$, $T_2(t)$ and $T_a(t) = [T_1(t) + T_2(t)]/2$.

The thermocouple giving signal $T_1(t)$ controls the fixed temperature rate. Temperature $T_2(t)$ increases slowly, and its rate of change depends on the speed of heat transport through the sample and on the dynamics of heat loss on its upper surface. That is why the linearity of the $T_2(t)$ dependence is slightly worse in comparison with the $T_1(t)$ course. However, the results shown in Fig. 2a indicate

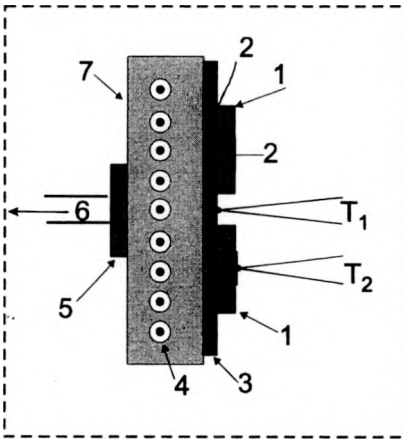

Fig. 1. Fragment of a TSDC measurement system: 1 – samples, 2 – electrodes, 3 – mica, 4 – heater, 5 – heat insulator, 6 – cooling, 7 – copper shield, T₁, T₂ – thermocouples.

that, with good approximation, the temperature gradient between the opposite surfaces of the sample increases linearly during the TSD experiment. Temperature $T_a(t)$ has been used in Sec. 3.3 (in accordance with the results of paper [8]) for calculation of the parameters W_a , P_0 and τ_0 of the relaxation process.

The experimental TSDC curves drawn separately for temperatures $T_1(t)$, $T_2(t)$ and $T_a(t)$ are shown in Fig. 2b. The results reflect a strong influence of the temperature gradient present in the SiO₂ xerogel on the TSDC spectra. The peak's position as well as the parameters describing the relaxation process depend on the choice of temperatures $T_1(t)$, $T_2(t)$ or $T_a(t)$. The theoretical results presented in paper [8] indicate that only $T_a(t)$ gives a correct description of the TSDC spectra obtained for the temperature gradient shown in Fig. 2a.

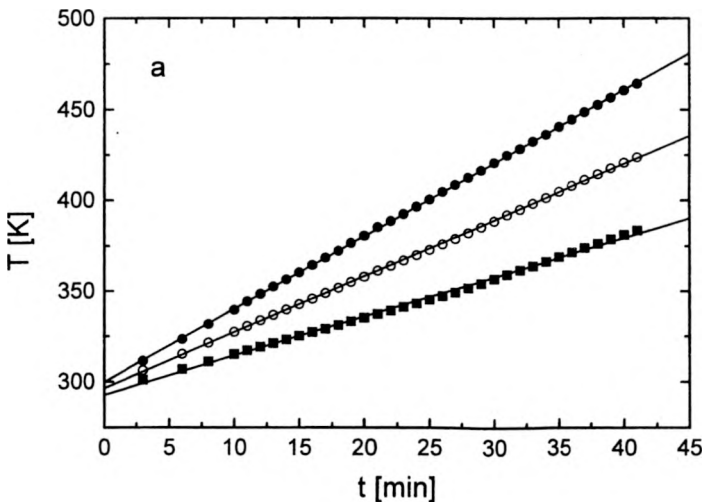

Fig. 2a

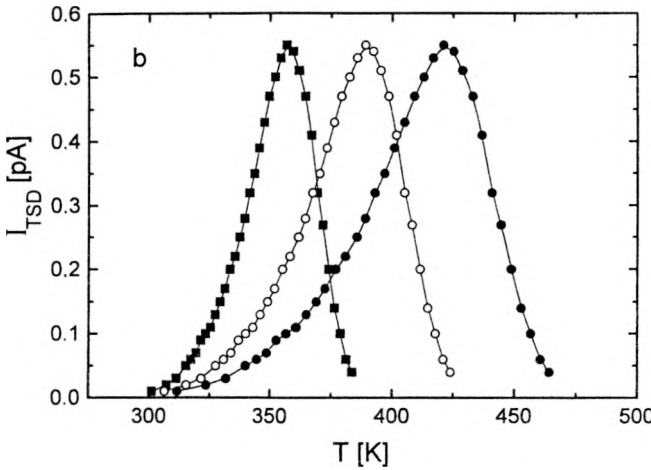

Fig. 2b

Fig. 2. a – Typical experimental course of temperatures during a TSDC experiment: ● – $T_1(t)$, ■ – $T_2(t)$, and ○ – $T_a(t) = [T_1(t) + T_2(t)]/2$. b – Experimental TSDC spectra drawn separately for temperature courses shown in a.

3. Results and discussion

3.1. Dipolar component of the TSDC spectrum

A typical TSDC spectrum of the investigated samples contains a dipole peak with a maximum below $T = 470$ K and a high temperature peak due to the space charge. The problems considered in the paper are limited to the dipolar component of the TSDC spectrum.

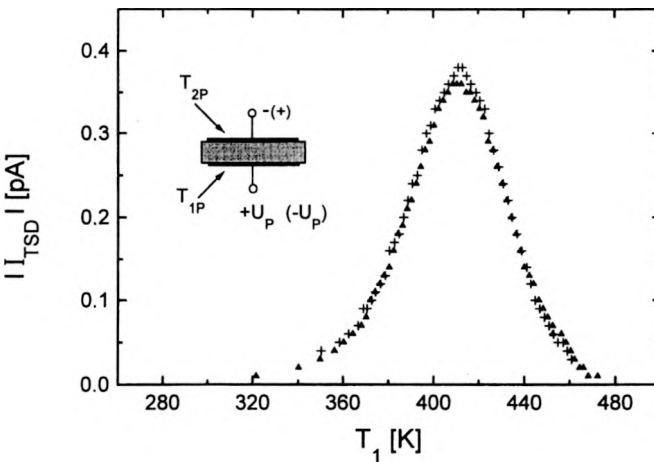

Fig. 3. TSDC spectra obtained for two opposite polarities of polarization voltage: ▲ – $U_p = +200$ V and + – $U_p = -200$ V with fixed temperature gradient ($T_{1p} = 393$ K and $T_{2p} = 349$ K).

Examination of the TSDC peak below the temperature $T = 470$ K provided four arguments in confirmation of the dipolar character of the peaks:

- i) the peak's amplitude is proportional to the voltage U_p applied during the polarization process (the samples were examined within the range of $U_p = 50 - 400$ V),
- ii) the amount of charge which is liberated by the depolarization process increases proportionally to U_p ,
- iii) the spectrum is insensitive to the change of U_p polarity (Fig. 3),
- iv) the peak reproducibility is very good.

Features i) and ii) are in accordance with the theoretical predictions for dipole relaxation [1]–[3]. The overlapping of the peaks shown in Fig. 3 is unlikely for space charge relaxation and confirms the dipole relaxation mechanism [7]. The good reproducibility of the TSDC peak is also characteristic for dipole relaxation and can hardly be found in space charge relaxation spectra [1].

3.2. Source of dipoles in silica xerogels

In our previous paper [12], we have suggested that the presence of dipoles in SiO_2 xerogels is connected with the peripheral molecular layer on the pores' surface. This layer consists of molecular groups such as Si-OH , SiO , Si-O-Si , Si-O^- , molecules of H_2O and OH^- ions [4], [13], [14]. In the case of ionically-doped xerogels molecules and ions of the dopant are also present.

A number of experiments have shown that the properties of the peripheral molecular layer, its molecular composition and mutual interactions within it can be modified by physical or chemical means, *e.g.*, change of pressure, heat treatment, doping [4], [5].

Such modifications are also reflected in the TSDC spectra of the investigated xerogels changing their amplitude and peak's position. The results presented in

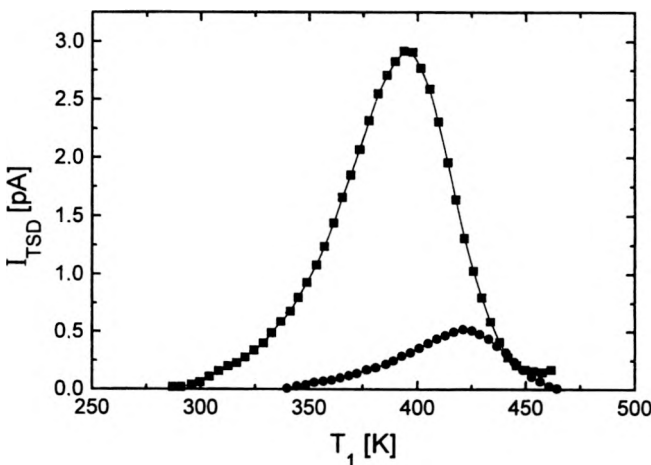

Fig. 4. Influence of thermal treatment of the sample in vacuum on TSDC spectra. Conditions of thermal treatment: $p \approx 4 \cdot 10^{-3}$ Pa, ● – $T_{1h} = 493$ K, and $t_h = 1$ h, ■ – $T_{1h} = 563$ K and $t_h = 3$ h.

Fig. 4 show the change of TSD spectrum caused by the thermal treatment of the sample in vacuum. The SiO_2 xerogels with a 0.01 mole RbCl dopant were treated in vacuum at different temperatures: $T_{1h} = 493$ K during time $t_h = 1$ h (spectrum ■) and $T_{1h} = 563$ K during time $t_h = 3$ h (spectrum ●). Following this procedure, both samples were polarized and depolarized under the same conditions. Apparently, heat treatment at higher temperatures caused a strong decrease in the number of relaxing dipoles. Additionally, the maximum of the spectrum has been shifted to higher temperatures.

During the high-temperature treatment procedure, the molecules which form dipoles weakly bounded to the SiO_2 skeleton of the xerogel are removed from the pores. Formally, we can consider H_2O , OH or O_2 molecules, while the molecules of water are the most probable. According to the results presented by AGAMALION and co-workers [15], the pore surface of SiO_2 contains three types of adsorbed water: a physisorbed layer and two types of chemisorbed layers (weakly and strongly bound). The relaxation processes of water molecules of adsorptive layer in porous glasses have recently been investigated by the dielectric losses method [16], [17].

In our experiment, the heat treatment in vacuum removes the physisorbed and weakly bound chemisorbed H_2O molecules from pores, leaving the strongly bound water clusters. This molecular process is reflected in the change of TSDC spectrum shown in Fig. 4.

Our investigations indicate that another contrary process is also possible. When, after high temperature treatment, the sample was stored during a long time in dynamic vacuum at room temperature, a slow increase of its TSDC signal took place and a peak shift to lower temperatures was observed. This effect can be explained as a slow resorption process of H_2O molecules on the pore surface due to small amounts of water molecules fed into dynamic vacuum under pressure $p \approx 4 \cdot 10^{-3}$ Pa.

3.3. Caclutaion of the parameters of relaxation processes

The complex structure of the peripheral molecular layer (various kinds of dipoles and weakly or strongly bound H_2O molecules) determines the complex structure of the TSDC spectra investigated. In the literature, one can find several experimental [1] or numerical [18], [19] methods which can be applied for complex spectral analysis. Taking into account the very low thermal conductivity of SiO_2 xerogels, the method of additive polarization [1] was used in our investigations. The approach of this method is to select single processes which form the total spectrum TSDC. The TSDC spectra were obtained for various fixed polarization temperatures T_{1p} in the order from low ($T_{1p} = 373$ K) to higher ($T_{1p} = 473$ K) temperatures, except for the last step of our experiment, when the polarization temperature returned to the value of $T_{1p} = 373$ K. As shown in Fig. 5, the TSD current after the last polarization procedure is not detectable.

The TSDC spectra in Fig. 5 show that the increase of polarization temperature T_{1p} causes a shift of the peaks into the region of higher temperatures and a change of their amplitude. The amplitude initially increases and begins to decrease for temperature T_{1p} above 415 K.

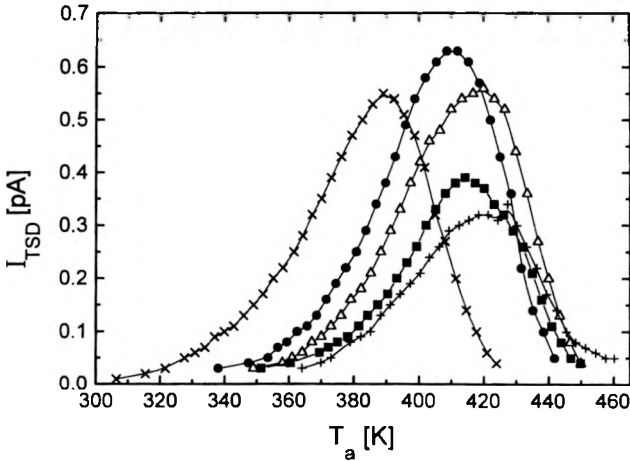

Fig. 5. Set of TSDC spectra obtained for various polarization temperatures T_{1p} (\times - $T_{1p} = 373$ K, \bullet - $T_{1p} = 413$ K, Δ - $T_{1p} = 433$ K, \blacksquare - $T_{1p} = 453$ K, $+$ - $T_{1p} = 473$ K).

The results described in this section support the explanation given in Sec. 3.2. Now, we may observe at which temperature the process of breaking the chemical bonds begins. This apparently occurs at a temperature of about $T \approx 420$ K, when the amplitude of the TSDC begins to decrease. The undetectable TSD current in the last experiment shown in Fig. 5 proves that the weakly bound dipoles are removed permanently from the pores.

Each of the spectra was analyzed for parameters $W(T_{1p})$, $P_0(T_{1p})$ and $\tau_0(T_{1p})$, which characterize a single relaxation process. However, in the case under investigation, the analysis should also take into consideration the temperature gradient in the sample. Theoretical considerations [8], [9] show that for such samples the mean activation energy W_i of the isolated relaxation process can be calculated with good accuracy using the Bucci-Fieschi-Guidi (BFG) plot [8], [20] or by the initial current rise (ICR) method [1], [9] for average temperature T_a . The BFG method has been used in our paper as, unlike the ICR method, it utilises the whole TSDC course.

In the case of nonuniform temperature distribution in the sample, the mean relaxation time of a dipole can be expressed as

$$\tau(x, t) = \tau_{0p} \exp \left[\frac{W}{kT(x, t)} \right], \quad (1)$$

and the BFG method is based on the formula [8]

$$\frac{j(T_a)}{P(T_a)} = \frac{1}{\tau_0} \exp \left[-\frac{W}{kT_a} \right], \quad (2)$$

with polarization

$$P(T_a) = \frac{1}{\beta_a \tau_a} \int_{\beta_a \tau_a}^{\infty} j(T'_a) dT'_a \quad (3)$$

where: $\beta_a = \frac{dT_a}{dt}$.

Thus, the plots of $\log[j(T_a)/P(T_a)]$ vs $1/T_a$ are linear and enable us to calculate the parameters of the relaxation process.

The experimental examples of the plots which satisfy Eqs. (1) and (2) are shown in Fig. 6. The activation energy W , initial polarization P_0 and pre-exponential factor τ_0 calculated for the TSDC spectra shown in Fig. 5 are presented in the Table.

Table. Parameters W , P_0 and τ_0 calculated for various polarization temperatures T_{1p} .

T_{1p} [K]	373	413	433	453	473	373*
W [eV]	0.61 ± 0.01	0.75 ± 0.01	0.77 ± 0.01	0.79 ± 0.01	0.73 ± 0.01	
P_0 [nC/cm ²]	5.5 ± 0.1	5.8 ± 0.1	5.3 ± 0.1	3.7 ± 0.1	3.4 ± 0.1	≈ 0
τ_0 [μ m]	5.7 ± 0.55	0.21 ± 0.29	0.18 ± 0.18	0.12 ± 0.18	0.80 ± 0.61	

*this experiment has been carried out at the end of the series.

The following conclusions result from the data collected: i) the relaxation process of weakly bound dipoles has expressly lower activation energy ($W \leq 0.61$ eV), ii) the activation energy of strongly bound dipoles $W = (0.73 - 0.79)$ eV is approximately double the experimental data of W obtained by Feldman and co-authors [17] for porous glasses, iii) the value of the pre-exponential factor τ_0 is about five orders of magnitude higher as compared with the data of paper [17]. The results of

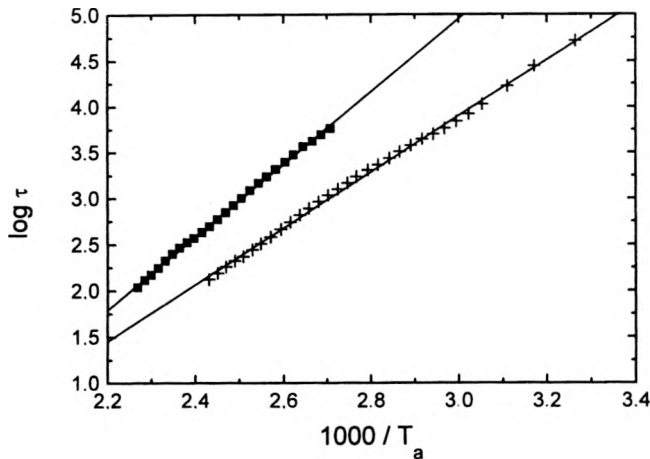

Fig. 6. Examples of the dependence $\log_{10}\tau$ vs $1000/T_a$, used for calculations of activation energy W and pre-exponential factor τ_0 (Eq. (1)).

investigations described in paper [17] are interpreted as a relaxation process due to reorientation of water molecules in the vicinity of a defect. Conclusions ii) and iii) suggest that the process investigated in our experiment may be connected with the relaxation of water molecules in a strongly chemisorbed layer existing in the form of clusters [15].

4. Summary

The method of thermally stimulated depolarization current has been used to investigate dipole relaxation processes in silica xerogels. The strong temperature gradient in the samples which accompanies the TSDC measurements requires changes, both in the measurement procedure and in processing the data. The results obtained in the experiment show that TSDC spectra for SiO₂ xerogels are very sensitive to the changes which take place in the peripheral molecular layer on the pores' surface. The relatively high values of activation energy W and the pre-exponential factor τ_0 obtained in our experiment suggest that the process under investigation is probably connected with relaxation of water molecules in strongly chemisorbed clusters.

References

- [1] GOROHOVATSKY Y., BORDOVSKY K., [Eds.], *Thermally Activated Current Spectroscopy of High-Resistance Semiconductors and Dielectrics*, (in Russian), Nauka, Moscow 1991.
- [2] SESSLER G.M., [Ed.], Springer-Verlag, Berlin 1980.
- [3] VAN TURNHOUT J., *Thermally Stimulated Discharge of Polymer Electrets*, Elsevier, Amsterdam 1975.
- [4] BRINKER C.J., SCHERER G.W., *Sol-Gel Science: The Physics and Chemistry of Sol-Gel Processing*, Academic Press, San Diego 1990.
- [5] SODOLSKI H., KOZŁOWSKI M., *J. Non-Crystal. Solids* **194** (1996), 241.
- [6] KATO K., HINO T., *Jpn J. Appl. Phys.* **26** (1986), 70.
- [7] GALCHINSKY O.V., ZAKHARO YA.M., KATERNYAK I.B., *Ukr. Fiz. Zhurnal* **37** (1992), 1249, (in Ukrainian).
- [8] TOMASZEWICZ W., SODOLSKI H., *Visnik Lviv. Univ. Ser. Fiz.*, 2001, in print.
- [9] KAVALIAUSKINE G.S., RINKEVICIUS V.S., *Litov. Fiz. Sbornik* **24** (1984), 34, (in Lithuanian).
- [10] KATO K., IWAMOTO M., HINO T., *IEEE Trans. Electr. Insul.* **22** (1987), 269.
- [11] *Ibidem*, p. 425.
- [12] SODOLSKI H., KOZŁOWSKI M., *Ceramics* **57** (1998), 73.
- [13] THUKIN G.D., APRETOVA A.I., *Zh. Prikl. Spektrosk.* **50** (1989), 639, (in Russian).
- [14] WANG B., SZU S., GREENBLATT M., *Solid State Ionics* **53/56** (1992), 1214.
- [15] AGAMALIAN M., DRAKE J.M., SINHA S.K., AXE J.D., *Phys. Rev E* **55** (1997), 3021.
- [16] GUTINA A., AXELROD E., PUZENKO A., *et al.*, *J. Non-Cryst. Solids* **235-237** (1998), 302.
- [17] FELDMAN Y., RYABOV Y., RYSIAKIEWICZ-PASEK E., *et al.*, *Ceramics* **57** (1998), 39.
- [18] ALDANA M., LAREDO E., BELLO A., SUAREZ N., *J. Polym. Sci., Part B: Polymer Physics* **32** (1994), 2197.
- [19] FAUBERT F., SANCHEZ M., *J. Appl. Phys.* **84** (1998), 1541.
- [20] BUCCI C., FIESCHI R., *Phys. Rev. Lett.* **12** (1964), 16.

Received September 18, 2000