

Lock-in phase analysis of copper phthalocyanine photoabsorption spectrum

MICHAŁ WOJDYŁA, BEATA DERKOWSKA, WACŁAW BAŁA

Institute of Physics, Nicolaus Copernicus University (UMK), Grudziądzka 5, 87-100 Toruń, Poland

The modulated photoabsorption (PA) spectra in Q -band spectral region of copper phthalocyanine (CuPc) thin layer have been investigated using two-channel lock-in phase resolved technique. Combining measurements in-phase and out-phase we determined four different features, which are observed in PA spectra. A detailed analysis of the in-phase and out-phase multicomponent PA spectra and corresponding phase diagram enabled separation of particular components as well as determination of their phase delay angle and corresponding time constants. In the CuPc sample under study, the various components of PA spectrum show different phase shifts, which implies different mechanism giving rise to the photoinduced electric field modulation.

Keywords: CuPc, thin layers, photoabsorption, absorption.

1. Introduction

Copper phthalocyanine (CuPc) is a very attractive p -type organic semiconductor for design of modern, high quality optoelectronic devices based on organic materials. Nowadays, the manufacture of flat, flexible displays with high brightness and power conversion efficiency seems to be possible only using organic materials. A very low cost of production of such organic devices in comparison with inorganic technology makes these materials serious rivals in electronic industry. Recent investigations have proved that using the CuPc material as a transport layer or hole injection buffer layer considerably improves efficiency and guarantees stability of organic light emitting diodes (OLED) [1, 2]. Other promising applications of molecular Pc layers take advantage of their photovoltaic properties. That is why these materials may find applications in efficient solar cells. Efficiency of organic solar cells can be improved by incorporation of various metal nanoclusters at the ITO-metallophthalocyanine interface [3]. Interesting physical properties such as low thermal conductivity, low melting point, low decomposition temperature and high chemical stability in air make these materials excellent candidates for production of storage media [4]. Optical limiting properties of metallophthalocyanine layers enable their application in the protection of eyes and optical sensors for high-intensity laser beams [5]. Moreover,

CuPc thin films are potentially applicable to field effect transistor, molecular gas sensors or organic memories [6].

A study of excited state-properties of quasi-one-dimensional molecular crystal CuPc is very important for a complete understanding of various phenomena in organic molecular solids. The absorption properties in the Q -band spectral region of metallophthalocyanines have been extensively studied but there is no consensus as to the number of transitions observed and their physical origination [7]. In this paper, we present a sensitive modulated spectroscopy for characterization of the low dimension CuPc structure. Thanks to the derivative nature of this method the broad features and shoulders of absorption spectrum can be changed to very sharp lines of a characteristic shape. In the case of CuPc layer modulated photoabsorption spectrum showed the existence of four distinct peaks in the Q -band spectral region.

2. Theory

Modulation techniques are particularly useful tools for characterizing bulk or low dimension semiconductor structures. Photoabsorption (PA) or photoreflectance (PR) are the most widely used modulation techniques because they do not require any special mounting of the sample. Moreover, PA is a very sensitive, non-destructive, contactless method, which provides information about energy gap, doping concentrations, trap states, built-in surface or interface electric field, *etc.* [8]. In the modulated spectroscopy important information can also be extracted from time dependences of variable signal. It was found that the absorption response to optical modulation does not take place immediately but it occurs after some phase delay of PA relative to the reference signal. The phase shift between the optical response and applied photomodulation is caused by the time limiting process of discharge, recharge, recombination or thermionic emission of the photogenerated excess carriers in surface, interface or bulk electronic states [9]. The time dependence of PA signal in the case of rectangular modulation can be described by exponential function with single characteristic time constants τ for the rise and fall of the PA signal [10]:

$$T(t) = \begin{cases} T_0 + \Delta T - \frac{\Delta T}{1 + \exp(-T'/2\tau)} \exp(-t/\tau) \rightarrow \text{laser on} \\ T_0 + \frac{\Delta T}{1 + \exp(-T'/2\tau)} \exp(-t + T'/2\tau) \rightarrow \text{laser off} \end{cases} \quad (1)$$

where T' is the modulation period ($T' = 1/f$), T – transmission, and t – the time.

A two-channel lock-in amplifier allows measurement of a complex signal consisting in-phase of the modulation component (X) as well as imaginary component (Y), which is shifted relative to the phase of the modulating light by 90° . The vector representation of the PA signal can be described by the equation:

$$\frac{\Delta T}{T}(E) = X(E) + iY(E) = C(E) \exp[i\phi(E)] \tag{2}$$

where $C(E)$ is an amplitude, $\phi(E)$ is a phase of the PA signal relative to the reference signal.

In the case where the PA spectrum consists of n components, the output from the lock-in amplifier under small modulation takes the simplified form [8, 11]:

$$\frac{\Delta T}{T} = \sum_j G_j (1 + 4\pi f^2 \tau_j^2)^{-1/2} \cos(\phi_{\text{ref}} - \phi_j) \tag{3}$$

where G_j is the line shape for j component, τ_j – the characteristic time constant, ϕ_{ref} – the preset lock-in reference phase, ϕ_j – the phase delay.

The dependence between τ_j , frequency of modulation f and phase delay angle ϕ_j for j component is given by the simple formula [12]:

$$\tan(\phi_j) = \frac{Y_j}{X_j} = -2\pi f \tau_j \tag{4}$$

where X_j and Y_j are in-phase and out-phase contributions to single components of the spectrum, respectively. Each of the components of the PA signal has its own phase delay ϕ_j and time constant τ_j . As a result each of the components has its specific vector representation in X-Y plane (Fig. 1.). The measured values of in-phase (X) and out-phase (Y) signals are generally projections of a vector sum of all existing components on the particular axes. Figure 1 and Eq. (3) show that there is a possibility of suppressing particular components of the PA spectrum by selecting ϕ_{ref} which

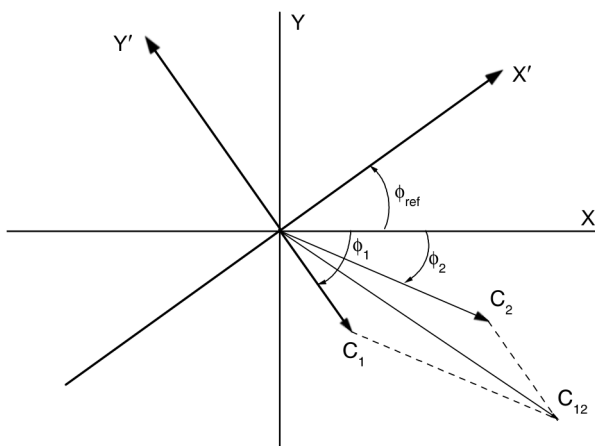

Fig. 1. Vector representation of the two components with different phase delay.

satisfies the equation $(\phi_{\text{ref}} - \phi_j) = 90^\circ$. From the reference phase, which suppressed a certain component we can find the phase delay ϕ_j and characteristic time constant τ_j using Eq. (4). In order to find suitable ϕ_{ref} corresponding to the total suppressing of appropriate component of the PA spectrum we can measure many spectra at a different angle ϕ_{ref} , which is preset in the lock-in amplifier. PA measurements are little time-consuming, so such an approach is rather ineffective. A more efficient way of finding this angle is to generate a series of spectra at varying angle ϕ_{ref} using equations which transform the co-ordinate system by rotation [13]. In the new, rotated X' - Y' co-ordinate system the projections of particular in-phase (X) and out-phase (Y) components are given by the equations:

$$X' = X \cos(\phi_{\text{ref}}) + Y \sin(\phi_{\text{ref}}), \quad (5)$$

$$Y' = -X \sin(\phi_{\text{ref}}) + Y \cos(\phi_{\text{ref}}). \quad (6)$$

Variation of the reference phase ϕ_{ref} causes that a certain component is no longer seen in the X' or Y' axis, whereas other components are still visible there.

In the situation when the PA spectrum is more complicated there is no easy way to extract particular phase shifting corresponding to the appropriate transitions, especially if there is no energy region where the spectrum is due to one component only. In this case, the separation of the particular components of spectra requires previous mathematical fitting to the experimentally obtained X and Y spectra assuming the number of transitions observed. Then, from the theoretical fitting procedure one should extract the shape of particular transitions for both X and Y channels. For each of the observed spectral components a corresponding linear phase diagram can be constructed. From the single component phase diagrams the phase delays of individual spectral components can be extracted by linear fitting or substituting calculated values X_j and Y_j into Eq. (4) [12, 13]. Moreover, knowledge of the mathematical form of line shape for each component gives a possibility of finding an appropriate phase delay using the transformation (rotation) co-ordinate system method described above. Substituting calculated values X_j and Y_j of a given transition into Eqs. (5) or (6) and looking for the angle ϕ_{ref} , which causes a total suppression of amplitude of the theoretically obtained function one can to determine a characteristic phase delay from the equation:

$$\phi_j = \phi_{\text{ref}} - 90^\circ \quad (X \text{ component suppressed}) \quad (7)$$

For $\phi_{\text{ref}} < 0$ (clockwise rotation) the Y component is suppressed, so that:

$$\phi_j = \phi_{\text{ref}}. \quad (8)$$

3. Experimental details

The CuPc layers have been prepared in vacuum chamber at a pressure of about $p = 2 \times 10^{-4}$ Pa. Purified CuPc powder (99.99% Sigma Aldrich Co.) was loaded into

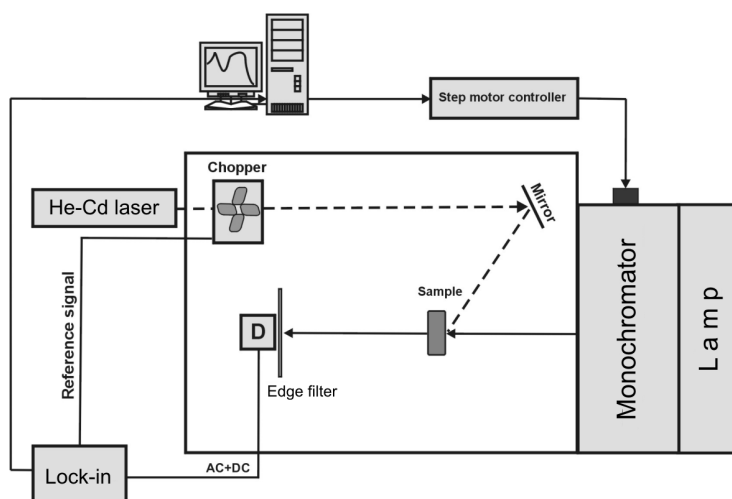

Fig. 2. Experimental set-up for photoabsorption spectroscopy.

a quartz effusion cell with a nozzle of 5 mm in diameter on the top. The glass substrates were located 10 cm above the source. The substrates were first sonicated in acetone, distilled water, isopropanol and finally in distilled water. Next, the substrates were moved into the deposition chamber where CuPc layers were deposited onto substrates at room temperature. The temperature of the CuPc source was about 640 K. The deposition rate was 0.2 nm/s.

The experimental set-up for measurements of the modulated PA spectra is presented in Fig. 2. The measurements were performed using a 250 W tungsten lamp as a probe source. The light from the lamp was dispersed by prism monochromator. Modulation of the sample surface electric field was produced by the photo-excitation created by mechanically chopped 42 mW helium-cadmium (Omnichrome 74) laser beam. A chopper was tuned to the lock-in (EG&G 7260) amplifier reference signal with frequency of 263 Hz. The change of reflectivity was measured by silicon photodiode using phase-sensitive techniques. The constant signal was measured by built-in lock-in analog to digital converter. In front of the detector an optical Schott edge filter was placed to eliminate influence of parasitic, scattered pump light. Measurements were carried out at room temperature.

4. Results and discussion

The absorption spectrum of a thin CuPc layer grown on glass substrate is presented in Fig. 3. The observed absorption band, frequently called *Q*-band, is dominated by two distinct peaks about 1.75 and 1.99 eV which have been attributed to the two Davydov components of the first π - π^* ($a_{1u} \rightarrow e_g$) transition on the phthalocyanine macrocycle [14–17]. In the absorption spectrum, there are also weakly visible shoulders at the energy of about 1.6 and 2.1 eV. The shoulder at 2.1 eV can be associated with

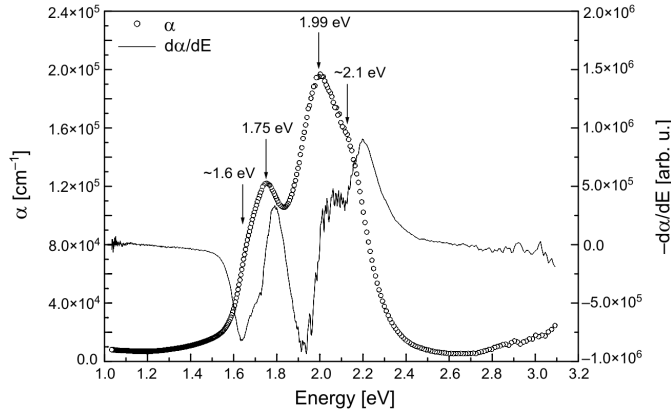

Fig. 3. Absorption spectrum (circle points) of CuPc layer and its derivatives (solid line).

vibrational interval whereas energetically lower shoulder at energy ~ 1.6 eV has been assigned to the charge transfer excitation [17, 18]. The presence of these shoulders in electronic structure of CuPc layer can be confirmed by plotting the first derivative of absorption spectrum. The shape of the first derivative of absorption spectrum is shown in Fig. 3. As we can see $d\alpha/dE$ exhibit few transitions, which can be identified only with the help of the complete mathematical-theoretical analysis. Figure 4 presents the experimental PA spectra of CuPc layer obtained for the X (square points) and Y (circle points) channels of the lock-in amplifier and corresponding fits (solid lines). The phase ϕ_{ref} was chosen equal -35° in order to obtain comparable signal amplitudes for the X and Y components. These spectra were fitted using third derivative line shape proposed by Aspnes and given by the formula [19]:

$$\frac{\Delta T}{T} = \sum_j^n \text{Re} \left[A_j \exp(i\varphi_j) (E - E_{gj} + i\Gamma_j)^{-m_j} \right] \quad (9)$$

where E_g is the energy band gap, Γ is a broadening parameter, A and φ are the amplitude and phase factor, respectively. Factor j denotes the number of spectral features. Parameter m depends on the type of the critical point and the order of the derivative. During the fitting procedure parameter m was assumed equal 2 like for excitonic transitions [20].

It can be noted that all transitions, even weakly visible ones, in absorption spectrum have been strongly enhanced in the case of modulated PA spectrum. Moreover, one can see that the in-phase (X) component of PA spectrum (Fig. 4) and the first derivative of absorption spectrum (Fig. 3) are almost similar in shape. This fact has proved the derivative nature of modulated spectra and convinced us that PA measurement has been carried out properly. The obtained PA in-phase (X) and out-phase (Y) spectra were preliminarily fitted assuming superposition of four components ($j = 4$ in Eq. (7)). Coincidence of the fitting parameters obtained from the fit to X and Y channels proved

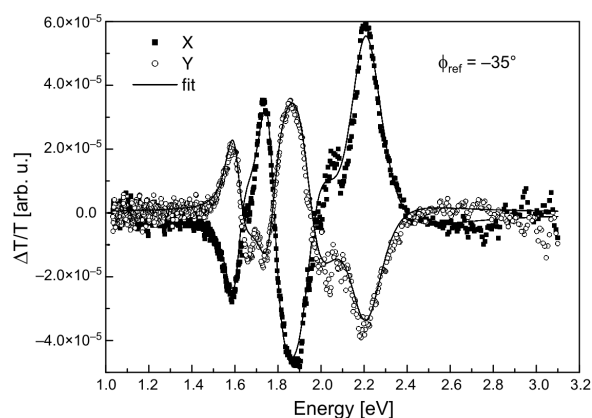

Fig. 4. Photoabsorption in-phase (X) and out-phase (Y) spectra fitted by Aspnes formula (solid lines).

that the assumed four-component nature of the PA spectrum was suitable. As final parameters we accepted average values of phases, energies and broadening obtained from fitting X and Y spectra. Subsequently, both in-phase (X) and out-phase (Y) spectra were fitted using the same model parameter values except the transition amplitude A . The fitting parameters obtained are collected in Tab. 1. Decomposition of fitted function (Eq. (7)) into particular transitions for both X and Y spectra is presented in Figs. 5 and 6, respectively. The accuracy of the fitting can be verified by comparison of the phase diagram constructed from experimentally obtained points with theoretical model, which was fitted to X and Y spectra. The experimental phase diagram has complicated, irregular form (see Fig. 7) but its shape has been well reconstructed. The phase shifts and time constants associated with particular transitions have been found from the ratios of imaginary (Y_j) to real (X_j) transition amplitudes A (Eq. (4)) and are presented in Tab. 2. Plotting the calculated Y_j and X_j values in the complex plane (Fig. 8) gives a linear phase diagram corresponding to individual components.

Table 1. Parameters obtained from fitting Aspnes model to photoabsorption in-phase and out-phase spectra.

Transition no.	Amplitude	Phase [rad]	Energy [eV]	Broadening [eV]
1	$-8.902 \times 10^{-8}(Y)$	-5.394	1.607	0.064
	$9.291 \times 10^{-8}(X)$			
2	$1.405 \times 10^{-7}(Y)$	0.779	1.766	0.079
	$-2.942 \times 10^{-7}(X)$			
3	$5.862 \times 10^{-7}(Y)$	-7.936	1.939	0.128
	$-5.869 \times 10^{-7}(X)$			
4	$6.264 \times 10^{-7}(Y)$	-6.528	2.199	0.147
	$-1.118 \times 10^{-6}(X)$			

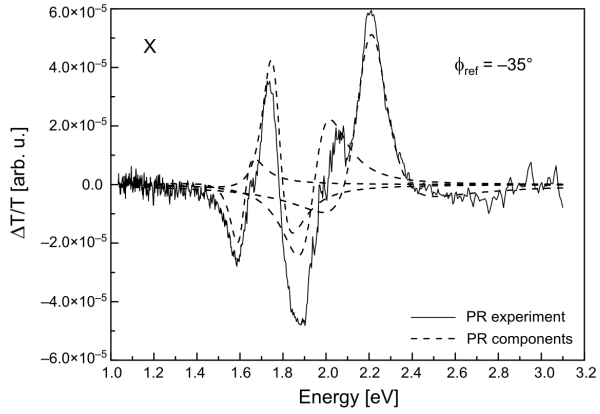

Fig. 5. Decomposition of in-phase (X) spectrum into particular transitions (dashed lines).

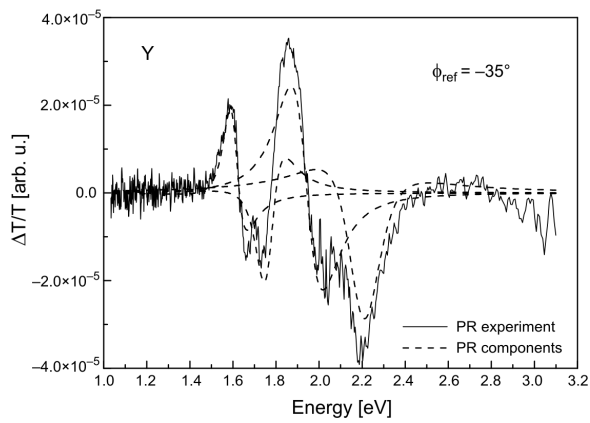

Fig. 6. Decomposition of out-phase (Y) spectrum into particular transitions (dashed lines).

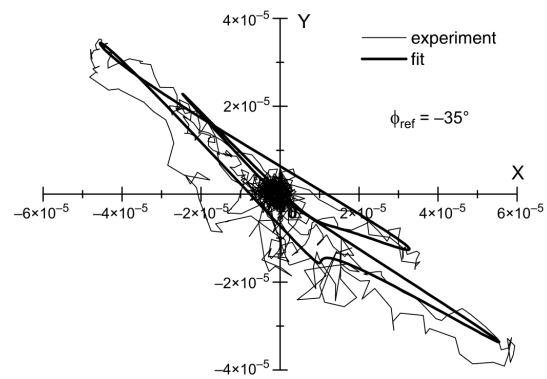

Fig. 7. Reconstruction (thick curve) of experimental phase diagram (thin curve) obtained from fitted to X and Y spectra Aspnes functions.

Table 2. Calculated values of phase delay angles and corresponding time constants.

Transition no.	Phase shift ($\phi_j = \phi_{\text{ref}} - 35^\circ$) [°]	Time constant τ_j [ms]
1	-79	3.1
2	-61	1.1
3	-80	3.4
4	-64	1.2

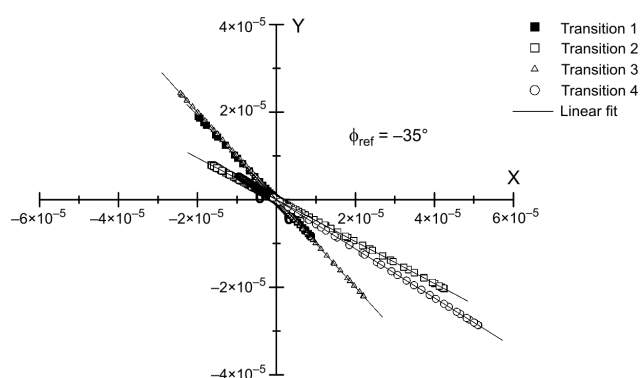

Fig. 8. Phase diagram corresponding to individual components (points) and its linear fitting (solid lines).

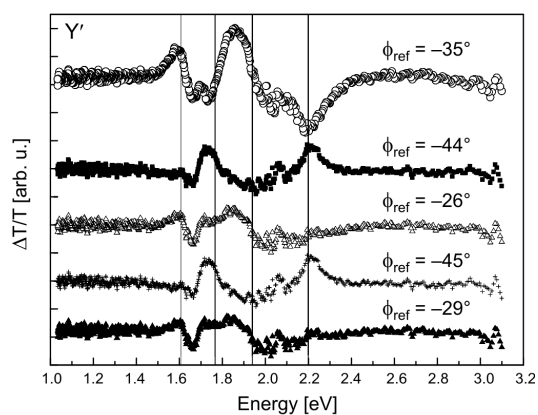

Fig. 9. Computer generated spectra for different angles ϕ_{ref} which correspond to the total suppression of particular transitions.

From the slope of particular $Y(X)$ linear function the phase delay can be found for each transition. The phase delay angles for each observed component have also been found using a procedure of transformation coordinate diagram which was described in the section dealing with theory. Figure 9 presents computer generated (using Eq. (6)) spectra for the angles ϕ_{ref} , which caused total suppression of amplitude connected with

particular transition. Vertical lines in Fig. 9 denote the resonance energy positions. Using this method and the previous one we obtained the same values of phase delay angles and corresponding time constants.

Calculated time constants (Tab. 2) corresponding to bands which were associated with the first π - π^* intramolecular transition (3), and charge transfer transition (1) are comparable and we can notice that they are about three times larger than for the others (2 and 4). However their conclusive interpretation remains difficult due to a variety of processes contributing to the observed time constants [13].

5. Summary

In this paper, optical properties of CuPc thin layer have been investigated using stationary and modulated PA spectroscopy. Obtained spectra are dominated by four different transitions but two of them are weakly visible in stationary absorption spectrum. Application of modulation technique allowed us to enhance the structure of the absorption spectrum and characterization of all four transitions observed. These resonance transitions have been attributed to the intramolecular π to π^* transitions as well as to the intermolecular charge transfer transition. PA spectrum has been fitted using four components of third derivative line shape given by Aspnes. The phase shift between the optical response and the applied photomodulation has been observed for all transitions. The phase shift and corresponding time constants associated with observed transitions have been determined by detailed analysis of in-phase and out-phase spectra and phase diagram. The calculated time constants have been found to be of the order of milliseconds.

References

- [1] KIM S.K., CHUNG T.G., CHUNG D.H., LEE H.S., SONG M.J., PARK J.W., LEE J.U., KIM T.W., *Improvement of efficiency in organic light-emitting diodes using PVK and CuPc buffer layer*, *Optical Materials* **21**(1-3), 2003, pp. 159–64.
- [2] TADAYYON S.M., GRANDIN H.M., GRIFFITHS K., NORTON P.R., AZIZ H., POPOVIC Z.D., *CuPc buffer layer role in OLED performance: a study of the interfacial band energies*, *Organic Electronics* **5**(4), 2004, pp. 157–66.
- [3] STENZEL O., STENDAL A., VOIGTSBERGER K., VON BORCZYKOWSKI C., *Enhancement of the photovoltaic conversion efficiency of copper phthalocyanine thin film devices by incorporation of metal clusters*, *Solar Energy and Solar Cells* **37**(3-4), 1995, pp. 337–48.
- [4] GU D., CHEN Q., TANG X., GAN F., SHEN S., LIU K., XU H., *Application of phthalocyanine thin films in optical recording*, *Optics Communications* **121**(4-6), 1995, pp. 125–9.
- [5] WANG P., ZHUANG S., WU P., YE CH., LIU H., XI F., *Optical limiting properties of optically active phthalocyanine derivatives*, *Chemical Physics Letters* **340**(3-4), 2001, pp. 261–6.
- [6] SZYBOWICZ M., RUNKA T., DROZDOWSKI M., BAŁA W., GRODZICKI A., PISZCZEK P., BRATKOWSKI A., *High temperature study of FT-IR and Raman scattering spectra of vacuum deposited CuPc thin films*, *Journal of Molecular Structure* **704**(1-3), 2004, pp. 107–13.
- [7] DJURISIC A.B., KWONG C.Y., LAU T.W., GUO W.L., LI E.H., LIU Z.T., KWOK H.S., LAM L.S.M., CHAN W.K., *Optical properties of copper phthalocyanine*, *Optics Communications* **205**(1-3), 2002, pp. 155–62.

- [8] SHEN H., DUTTA M., *Franz–Keldysh oscillations in modulation spectroscopy*, Journal of Applied Physics **78**(4), 1995, pp. 2151–76.
- [9] SCHREIBER J., KIRCHER W., HILDEBRANDT S., GANSHA A., KUZMENKO R., *Lock-in phase studies of E_0 PR spectra on GaAs*, Proc. Workshop on Highlights of Light Spectroscopy on Semiconductors (HOLSOS 95), Frascati 1995, pp. 29–32.
- [10] GANZHA A.V., KUSMENKO R.V., KIRCHER W., SCHREIBER J., HILDEBRANDT S., *Lock-in-phase analysis of n-GaAs photoreflectance spectra*, Semiconductors **32**(3), 1998, pp. 245–9.
- [11] MISIEWICZ J., SITAREK P., SĘK G., *Introduction to the photoreflectance spectroscopy of semiconductor structures*, OW PWr, Wrocław 1999.
- [12] KUZ'MENKO R., GANZHA A., SCHREIBER J., HILDEBRANDT S., *Identification of the multicomponent nature of E_0 photoreflectance spectra from moderately doped GaAs substrates*, Physics of the Solid State **39**(12), 1997, pp. 1900–5.
- [13] HILDEBRANDT S., MURTAGH M., KUZMENKO R., KIRCHER W., SCHREIBER J., *Analysis of synchronous phase, pump power, and pump wavelength dependent complex PR spectra from GaAs MBE structures*, Physica Status Solidi A **152**(1), 1995, pp. 147–60.
- [14] EL-NAHASS M.M., BAHABRI F.S., AL-HARABI R., *Optical properties of copper phthalocyanine (CuPc) thin films*, Egyptian Journal of Solids **24**(1), 2001, pp. 11–9.
- [15] NUESCH F., CARRARA M., SCHAER M., ROMERO D.B., ZUPPIROLI L., *The role of copper phthalocyanine for charge injection into organic light emitting devices*, Chemical Physics Letters **347**(4–6), 2001, pp. 311–7.
- [16] STENDAL A., BECKERS U., WILBRANDT S., STENZEL O., VON BORCZYKOWSKI C., *The linear optical constants of thin phthalocyanine and fullerite films from the near infrared up to the UV spectral regions: estimation of electronic oscillator strength values*, Journal of Physics B: Atomic, Molecular and Optical Physics **29**(12), 1996, pp. 2589–95.
- [17] LEZNOFF C.C., LEVER A.B.P., *Phthalocyanines, Properties and Applications*, VCH Publishers, New York 1989.
- [18] KNUPFER M., SCHWIEGER T., PIESERT H., FINK J., *Mixing of Frenkel and charge transfer excitons in quasi-one-dimensional copper phthalocyanine molecular crystals*, Physical Review B: Condensed Matter and Materials Physics **69**(16), 2004, pp. 165210/1–5.
- [19] HARAGUCHI M., NAKAGAWA Y., FUKUI M., MUTO S., *Two modulation mechanisms for photoreflectance from GaAs/AlAs multiple quantum well*, Superlattices and Microstructures **13**(3), 1993, pp. 341–6.
- [20] MISIEWICZ J., SĘK G., KUDRAWIEC R., SITAREK P., *Photomodulated reflectance and transmittance: optical characterisation of novel semiconductor materials and device structures*, Thin Solid Films **450**(1), 2004, pp. 14–22.

Received June 6, 2005